

# R&S<sup>®</sup>SMW-K540, R&S<sup>®</sup>SMW-K541

## Envelope Tracking and AM/AM, AM/PM Predistortion

### User Manual



1176.9506.02 – 07

This document describes the following software options:

- R&S®SMW-K540  
1413.7215.xx
- R&S®SMW-K541  
1413.7267.xx

This manual describes firmware version FW 3.20.324.xx and later of the R&S®SMW200A.

© 2015 Rohde & Schwarz GmbH & Co. KG

Mühlhofstr. 15, 81671 München, Germany

Phone: +49 89 41 29 - 0

Fax: +49 89 41 29 12 164

Email: [info@rohde-schwarz.com](mailto:info@rohde-schwarz.com)

Internet: [www.rohde-schwarz.com](http://www.rohde-schwarz.com)

Subject to change – Data without tolerance limits is not binding.

R&S® is a registered trademark of Rohde & Schwarz GmbH & Co. KG.

Trade names are trademarks of the owners.

The following abbreviations are used throughout this manual: R&S®SMW200A is abbreviated as R&S SMW; the license types 02/03/07/11/13/16/12 are abbreviated as xx.

# Contents

<b>1</b>	<b>Preface</b> .....	<b>5</b>
1.1	About this Manual.....	5
1.2	Documentation Overview.....	5
1.3	Conventions Used in the Documentation.....	7
1.3.1	Typographical Conventions.....	7
1.3.2	Conventions for Procedure Descriptions.....	8
1.3.3	Notes on Screenshots.....	8
<b>2</b>	<b>Welcome to the R&amp;S SMW-K540/-K541 Options</b> .....	<b>9</b>
2.1	Accessing the Required Settings.....	10
2.2	Scope.....	10
<b>3</b>	<b>Generation of Envelope Tracking Signals</b> .....	<b>11</b>
3.1	Required Options.....	11
3.2	About the Envelope Tracking.....	11
3.2.1	Envelope Voltage Adaptation Modes.....	12
3.2.2	Signal Parameters for Testing According to the eTrak® Specification.....	13
3.2.3	Envelope Shaping and Shaping Methods.....	13
3.2.3.1	About the Linear Functions.....	14
3.2.3.2	About the Detrouching Function.....	15
3.2.3.3	About the Polynomial Function.....	15
3.2.3.4	About the Shaping Table.....	16
3.2.3.5	Shaping Function in Raw Data Format.....	17
3.2.3.6	Converting Shaping Functions and Understanding the Displayed Values.....	17
3.3	General RF Envelope Settings.....	22
3.4	Envelope Settings.....	31
3.5	Shaping Settings.....	33
3.6	Edit I/Q Envelope Shape Settings.....	41
3.7	Polynomial Coefficients Setting.....	43
<b>4</b>	<b>Applying Digital Predistortion</b> .....	<b>46</b>
4.1	Required Options.....	46
4.2	About Digital Predistortion.....	46

4.2.1	Defining the Power Level of the Generated Signal.....	47
4.2.2	Defining the Correction Values.....	48
4.2.2.1	Polynomial Function.....	48
4.2.2.2	Shaping Table.....	49
4.2.2.3	Normalized Data.....	50
4.2.2.4	Predistortion Function in Raw Data Format.....	51
4.2.3	Finding Out the Correction Values.....	52
<b>4.3</b>	<b>Digital Predistortions AM/AM and AM/PM Settings.....</b>	<b>53</b>
4.3.1	General Settings.....	53
4.3.2	Predistortion Settings.....	56
4.3.3	Edit Predistortion Table Settings.....	60
4.3.4	Polynomial Coefficients Settings.....	62
4.3.5	Normalized Data Settings.....	66
<b>4.4</b>	<b>Compensating Non-linear RF Effects.....</b>	<b>67</b>
<b>5</b>	<b>How to Generate a Control Signal for Power Amplifier Envelope Tracking Tests.....</b>	<b>70</b>
<b>6</b>	<b>How to Apply a Digital Predistortion to Improve the Efficiency of RF Power Amplifiers.....</b>	<b>74</b>
<b>7</b>	<b>Remote-Control Commands.....</b>	<b>80</b>
7.1	SOURce:IQ:OUTPut Subsystem.....	81
7.2	SOURce:IQ:OUTPut:ENVELOpe Commands.....	83
7.3	SOURce:IQ:DPD Subsystem.....	99
	<b>List of Commands.....</b>	<b>114</b>
	<b>Index.....</b>	<b>117</b>

# 1 Preface

## 1.1 About this Manual

This User Manual provides all the information **specific to the options R&S SMW-K540/-K541**. All general instrument functions and settings common to all applications and operating modes are described in the main R&S SMW user manual.

The main focus in this manual is on the provided settings and the tasks required to generate a signal. The following topics are included:

- **Welcome to the Envelope Tracking and Digital Predistortion options R&S SMW-K540/-K541**  
Introduction to and getting familiar with the option
- **About the Envelope Tracking and Digital Predistortion**  
Background information on basic terms and principles in the context of the signal generation
- **Configuration and Settings**  
A concise description of all functions and settings available to configure signal generation with their corresponding remote control command
- **How to Generate a Signal with the R&S SMW-K540/-K541 Options**  
The basic procedure to perform signal generation tasks and step-by-step instructions for more complex tasks or alternative methods  
As well as detailed examples to guide you through typical signal generation scenarios and allow you to try out the application immediately
- **Typical Applications/Application Examples**  
Example signal generation scenarios in which the option is frequently used.
- **Remote Control Commands**  
Remote commands required to configure and perform signal generation in a remote environment, sorted by tasks  
(Commands required to set up the instrument or to perform common tasks on the instrument are provided in the R&S SMW user manual)  
Programming examples demonstrate the use of many commands and can usually be executed directly for test purposes
- **List of remote commands**  
Alphabetical list of all remote commands described in the manual
- **Index**

## 1.2 Documentation Overview

The user documentation for the R&S SMW consists of the following parts:

- Getting started, printed manual
- Online help system on the instrument, incl. tutorials
- User manuals and online manual, see the product page

- Service manual, provided on the internet for registered users
- Instrument security procedures, see the product page
- General safety instructions, printed brochure
- Release notes, see the product page (download > firmware)
- Data sheet and brochures, see the product page (download > brochures and data sheets)
- Application notes, provided on the internet



You find the user documentation on the R&S SMW product page mainly at:

<http://www.rohde-schwarz.com/product/SMW200A.html> > "Downloads" > "Manuals"

Additional download paths are stated directly in the following abstracts of the documentation types.

### Getting Started

Introduces the R&S SMW and describes how to set up and start working with the product. Includes basic operations, typical measurement examples, and general information, e.g. safety instructions, etc.

### Online Help and Tutorials

The **online help** offers quick, context-sensitive access to the information needed for operation and programming. It contains the description for the base unit and the software options.

The **tutorials** offer guided examples and demonstrations on operating the R&S SMW.

### User Manual and Online Manual

Separate manuals are provided for the base unit and the software options:

- **Base unit manual**  
Contains the description of the graphical user interface, an introduction to remote control, the description of all SCPI remote control commands, programming examples, and information on maintenance, instrument interfaces and error messages. Includes the contents of the getting started manual.
- **Software option manuals**  
Describe the specific functions of an option. Basic information on operating the R&S SMW is not included.

The **online manual** provides the contents of the user manual for immediate display on the internet.

### Service Manual

Describes the performance test for checking the rated specifications, module replacement and repair, firmware update, troubleshooting and fault elimination, and contains mechanical drawings and spare part lists.

The service manual is available for registered users on the global Rohde & Schwarz information system (GLORIS).

**Instrument Security Procedures**

Deals with security issues when working with the R&S SMW in secure areas.

**Data Sheets and Brochures**

The data sheet contains the technical specifications of the R&S SMW. Brochures provide an overview of the instrument and deal with the specific characteristics, see <http://www.rohde-schwarz.com/product/SMW200A.html> > "Download" > "Brochures and Data Sheets".

**General Safety Instructions**

Contains basic safety instructions in English, Spanish, German and French.

**Release Notes**

Describes the firmware installation, new and modified features and fixed issues according to the current firmware version. You find the latest version at:

<http://www.rohde-schwarz.com/product/SMW200A.html> > "Downloads" > "Firmware"

**Application Notes, Application Cards, White Papers, etc.**

These documents deal with special applications or background information on particular topics, see <http://www.rohde-schwarz.com/appnotes>.

## 1.3 Conventions Used in the Documentation

### 1.3.1 Typographical Conventions

The following text markers are used throughout this documentation:

Convention	Description
"Graphical user interface elements"	All names of graphical user interface elements on the screen, such as dialog boxes, menus, options, buttons, and softkeys are enclosed by quotation marks.
KEYS	Key names are written in capital letters.
File names, commands, program code	File names, commands, coding samples and screen output are distinguished by their font.
<i>Input</i>	Input to be entered by the user is displayed in italics.
<a href="#">Links</a>	Links that you can click are displayed in blue font.
"References"	References to other parts of the documentation are enclosed by quotation marks.

### 1.3.2 Conventions for Procedure Descriptions

When describing how to operate the instrument, several alternative methods may be available to perform the same task. In this case, the procedure using the touchscreen is described. Any elements that can be activated by touching can also be clicked using an additionally connected mouse. The alternative procedure using the keys on the instrument or the on-screen keyboard is only described if it deviates from the standard operating procedures.

The term "select" may refer to any of the described methods, i.e. using a finger on the touchscreen, a mouse pointer in the display, or a key on the instrument or on a keyboard.

### 1.3.3 Notes on Screenshots

When describing the functions of the product, we use sample screenshots. These screenshots are meant to illustrate as much as possible of the provided functions and possible interdependencies between parameters. The shown values may not represent realistic test situations.

The screenshots usually show a fully equipped product, that is: with all options installed. Thus, some functions shown in the screenshots may not be available in your particular product configuration.



## 2 Welcome to the R&S SMW-K540/-K541 Options

The R&S SMW-K540 is a software option that allows you to generate an envelope tracking signal, that follows the envelope variation of the RF signal.

### R&S SMW-K540 key features

- Baseband signal, RF signal, and envelope signal generation out of one instrument
- Envelope signal derived directly and in real time from the baseband signal
- Fully synchronous envelope and RF signal with optional delay compensation for time alignment of the envelope signal
- Simultaneous output of envelope and inverted envelope signal
- Flexible envelope shaping based on different algorithms incl. a build-in table shaping editor
- Import/export interface for files describing shaping functions
- Real-time display of the characteristics of the envelope signal

The R&S SMW-K541 is a software option that adds functionality to define and apply AM/AM and AM/PM predistortions.

### R&S SMW-K541 key features

- Applying user-defined AM/AM and AM/PM digital predistortions directly on the digital baseband signal
- Digital predistortions are applied directly and in real time to the baseband signal, i.e. to any Digital Standard signal or with ARB waveforms
- Separate or superimposed AM/AM or AM/PM predistortion also with variable order in the processing flow
- Flexible shaping of the predistortion functions based on a polynomial function and a build-in table editor
- Import/export interface for files describing the predistortion functions, i.e. load of AM/AM and AM/PM tables directly from characterization software
- Real-time display of the correction functions
- In instruments equipped with the option R&S SMW-K540, digitally predistorted baseband signal, RF signal, and envelope signal generation out of one instrument

This user manual contains a description of the functionality that the application provides, including remote control operation.

All functions not discussed in this manual are the same as in the base unit and are described in the R&S SMW user manual. The latest version is available at the R&S SMW [product page](#) >"Downloads" > "Manuals".

### Installation

You can find detailed installation instructions in the delivery of the option or in the R&S SMW Service Manual.

## 2.1 Accessing the Required Settings

### To open the dialog with Envelope Tracking settings

1. In the block diagram of the R&S SMW, select the I/Q OUT 1/2 connector to unfold the "I/Q Analog" block.

A dialog box opens that displays the provided general settings.

2. Select "I/Q Analog > I/Q Analog Settings > General".
3. Select "RF Envelope > On".

### To open the dialog with DPD settings

- ▶ In the block diagram of the R&S SMW, select "I/Q Mod > Digital Predistortion > AM/AM AM/PM".

A dialog box opens that displays the provided settings.

The signal generation is not started immediately. To start signal generation with the default settings, select "State > On".

## 2.2 Scope



Tasks (in manual or remote operation) that are also performed in the base unit in the same way are not described here.

In particular, this includes:

- Managing settings and data lists, like storing and loading settings, creating and accessing data lists, or accessing files in a particular directory.
- Information on regular trigger, marker and clock signals, and filter settings, if appropriate.
- General instrument configuration, such as checking the system configuration, configuring networks and remote operation
- Using the common status registers

For a description of such tasks, see the R&S SMW user manual.

## 3 Generation of Envelope Tracking Signals

The envelope tracking (ET) is a method used by modern power amplifiers (PA) to improve their efficiency, especially when they amplify RF signals with a high peak to average power (PAPR). An envelope tracking detector "tracks" the power variations in the input signal of the PA; the PA then varies synchronously to this variation the supply voltage  $v_{cc}$  at its end amplifying stage.

This section introduces the concept of the envelope tracking functionality and the way it is implemented in the R&S SMW.

Refer to [Chapter 5, "How to Generate a Control Signal for Power Amplifier Envelope Tracking Tests"](#), on page 70 for step-by-step instruction on how to use the provided function.

### 3.1 Required Options

The equipment layout for generation and output of envelope tracking signal includes:

- Option Baseband Generator (R&S SMW-B10) per signal path and Option Baseband main module, one/two I/Q paths to RF (R&S SMW-B13/B13T) Incl. output the baseband signal at the single ended outputs
- Option Differential Analog I/Q Outputs (R&S SMW-K16) per signal path
- Option Envelope Tracking (R&S SMW-K540) per signal path
- Optional option AM/AM AM/PM Predistortion (R&S SMW-K541) per signal path

### 3.2 About the Envelope Tracking

Provided the required options are installed, the R&S SMW allows you to generate an envelope tracking signal, that follows the envelope variation of the RF signal.

#### Principle of the envelope tracking

The [Figure 3-1](#) shows a simplified test setup for testing of a PA with an envelope tracking. This illustration is intended to explain the principle in general, not all connections and required equipment are considered.

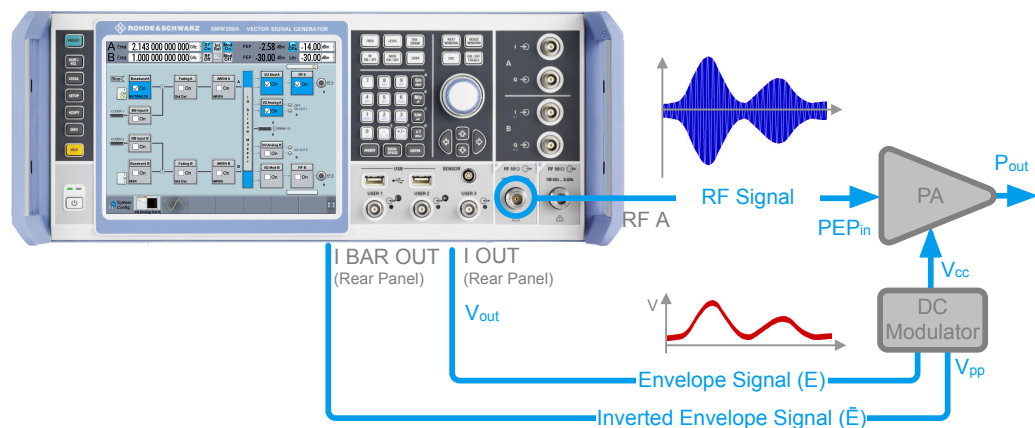

**Figure 3-1: Simplified test setup for power amplifier envelope tracking tests**

The R&S SMW in this setup is configured to generate both, an RF signal with complex modulation scheme and an envelope signal, that follows the envelope variation of this RF signal. A suitable test signal is for example an EUTRA/LTE DL signal.

The R&S SMW generates the envelope signal directly from the baseband signal. The envelope signal is a voltage signal, with voltage level  $V_{out}$  proportional to the power of the RF signal ( $\sqrt{I(t)^2+Q(t)^2}$ ) of the corresponding path. If you do not apply a shaping function, the envelope signal follows the variation of the envelope of the RF signal linearly dependent.

The envelope signal is output at the I OUT and I BAR OUT rear panel connectors. This envelope signal is then further fed to an external DC modulator.

The PA receives the RF input signal and the dynamically adapted supply voltage  $v_{cc}$ . Ideally, the PA gain should stay constant.

### Suitable baseband signal to observe the effect of the envelope tracking settings

To simplify the explanation in the following sections, we use a simple ramp function as a baseband signal modulated on the RF carrier.

Other suitable baseband signals are signals with relative constant envelope. You find a choice of predefined signals in the "Baseband > Custom Dig Mod" dialog. For instance, with the default settings in this dialog ("Custom Dig Mod > Set acc. to the standard > GSM"), you can observe the generated envelope signal and the effects of enabled shaping.

## 3.2.1 Envelope Voltage Adaptation Modes

In the R&S SMW, you define the voltage of the generated envelope signal using one of the following modes:

- **Auto Power/Normalized Envelope Voltage Adaptation:**  
In this mode, you define the desired input characteristics of the power amplifier.

Based on these values and depending on the crest factor of the currently generated signal, the R&S SMW calculates:

- The voltage on the I OUT/I BAR OUT connectors ( $V_{outMin/Max}$ ) and a bias (Bias),
- The RMS level of the RF signal

The auto voltage adaptation mode is a suitable choice, if you have knowledge on the power amplifier components and characteristics, like for example the supply voltage  $V_{cc}$ , the input power  $PEP_{in}$  required for working in the linear range, as well as the gain characteristics of the external DC modulator.

You find the required values in the documentation of your power amplifier, for example in its data sheet.

- **Manual Envelope Voltage Adaptation:**

In this mode, you can additionally define the operating range of the power amplifier based on a pre-gain and a post-gain range. Based on these values, the instrument calculates the supply voltage  $V_{cc}$ .

All modes support envelope shaping.

### 3.2.2 Signal Parameters for Testing According to the eTrak® Specification

In the R&S SMW, you can select one of the predefined eTrak® interface types so that the generated signal is conform with the MIPI®Alliance specification "Analog Reference Interface for Envelope Tracking Specification".

*Table 3-1: Default parameters per eTrak® Interface Type*

Parameter	1.2 Vpp	1.5 Vpp	2 Vpp
I/Q output Type	Differential	Differential	Differential
Bias	500 mV	600 mV	900 mV
Vpp Max	1.2 V	1.5 V	2 V
Vcc Max	1.2 V	1.5 V	2 V
Bipolar Input	On	On	On

### 3.2.3 Envelope Shaping and Shaping Methods

Envelope shaping is a method that uses functions to describe the relationship between supply voltage and RF input power. An envelope shaping function is a trade-off between effectivity and improved linearity of the PA.

In the R&S SMW, you can select the way you define the shaping function. You can choose between:

- 2 predefined simple linear functions  
(see [Chapter 3.2.3.1, "About the Linear Functions"](#), on page 14)
- 3 detroughing functions with a configurable factor  
(see [Chapter 3.2.3.2, "About the Detroughing Function"](#), on page 15)

- A polynomial function with up to 10 polynomial coefficients (see [Chapter 3.2.3.3, "About the Polynomial Function"](#), on page 15)
- A shaping function defined as a shaping table (see [Chapter 3.2.3.4, "About the Shaping Table"](#), on page 16)
- To set the correction values in raw format with a single remote control command (see [Chapter 3.2.3.5, "Shaping Function in Raw Data Format"](#), on page 17)

The linear, the detrouthing and the polynomial shaping functions are mathematical expressions that are described as function of the variable  $x$ , see [Table 3-2](#).

**Table 3-2: Definition of the variable  $x$  depending on the envelope voltage adaptation mode**

"Envelope Voltage Adaptation"	$x$
Auto Power	$x = V_{in} - V_{in, min}$ $x \geq 0$
Auto Normalized	$x = V_{in}/V_{in, max}$
Manual	$x = V_{Env}/V_{Env, max}$

The mathematical expressions and further information on the shaping functions are provided in the corresponding sections.

See also [Chapter 3.2.3.6, "Converting Shaping Functions and Understanding the Displayed Values"](#), on page 17.

- [About the Linear Functions](#)..... 14
- [About the Detrouthing Function](#)..... 15
- [About the Polynomial Function](#)..... 15
- [About the Shaping Table](#)..... 16
- [Shaping Function in Raw Data Format](#)..... 17
- [Converting Shaping Functions and Understanding the Displayed Values](#)..... 17

### 3.2.3.1 About the Linear Functions

The linear shaping can be used for less demanding applications, simple analysis, and the first interactions by designing the optimum envelope shape. Because the shaping gain of the linear function is 0 dB, in "Envelope Voltage Adaptation > Manual" mode this function is suitable for determining the "Pre-/Post-Gain" values (see [Example "Calculating the current  \$V\_{CC}\$  in "Manual" mode"](#) on page 21).

Provided are two linear functions, where each of them depends on the "Envelope Voltage Adaptation" mode:

- Linear (Voltage)
  - $f(x) = x$  in "Auto Normalized/Manual"
  - $f(x) = b \cdot x + V_{cc, min}$  in "Auto Power"
- Linear (Power)
  - $f(x) = x^2$  in "Auto Normalized/Manual"
  - $f(x) = b \cdot x^2 + V_{cc, min}$  in "Auto Power"

Where:

- the variable  $x$  depends on the "Envelope Voltage Adaptation" mode, see [Table 3-2](#).
- The constant  $b$  is calculated as:  

$$b = (V_{cc,max} - V_{cc,min}) / (V_{in,max} - V_{in,min})$$

See also [Chapter 3.2.3.6, "Converting Shaping Functions and Understanding the Displayed Values"](#), on page 17.

### 3.2.3.2 About the Detroughing Function

Detroughing functions are well-defined mathematical functions that prevent that the supply voltage  $V_{cc}$  drops down to zero or falls under specified limits. That is, they prevent that the signal is clipped.

Provided are the following functions:

- $f(x) = x + d \cdot e^{-x/d}$
- $f(x) = 1 - (1 - d) \cdot \cos(x \cdot \pi/2)$
- $f(x) = d + (1 - d) \cdot x^a$

Where:

- $x$  is a variable, that depends on the "Envelope Voltage Adaptation" mode, see [Table 3-2](#)
- $a$  is the [Exponent \(a\)](#)
- $d$  is the [Detroughing Factor \(d\)](#), that limit the supply voltage  $V_{cc}$  in the low-power region and controls the shaping.  
 The detroughing factor ( $d$ ) can be set manually or derived from the selected  $V_{cc}$  value. In the latter case, it is calculated as follows:  

$$d = V_{cc,min} / V_{cc,max}$$
 See [Couple Detroughing Factor with Vcc](#).  
 A "Detroughing Factor = 0" defines a linear function.

See also [Chapter 3.2.3.6, "Converting Shaping Functions and Understanding the Displayed Values"](#), on page 17.

### 3.2.3.3 About the Polynomial Function

The polynomial function is an analytical method to describe a shaping function. The polynomial function is defined as follows:

$f(x) = a_0 + \sum(a_n \cdot x^n)$ , where  $n \leq 10$  and:

- Depending on the "Envelope Voltage Adaptation" mode,  $f(x)$  is:
  - $f(x) = V_{cc}(x)$  in "Auto Power"
  - $f(x) = V_{cc} / V_{cc,max}(x)$  in "Auto Normalized/Manual"
- The polynomial order  $n$ , the polynomial constant  $a_0$ , and polynomial coefficients  $a_0$  to  $a_n$  are user-definable, see [Chapter 3.7, "Polynomial Coefficients Setting"](#), on page 43
- $x$  depends on the "Envelope Voltage Adaptation" mode, see [Table 3-2](#)

The default polynomial function with  $n = 1$ ,  $a_0 = 0$  and  $a_1 = 1$  describes a linear function.

See also

- [Figure 3-13](#)
- [Chapter 3.2.3.6, "Converting Shaping Functions and Understanding the Displayed Values"](#), on page 17.

#### File format of the polynomial function file

You can store a polynomial function in a file or even define the polynomial coefficients, store them as a file and load this file into the instrument. The polynomial files are files with extension `*.iq_poly`.

The file contains an optional header `# Rohde & Schwarz - IQ Output Envelope Polynomial Coefficients # a0,a1,a2,...` and a list of comma-separated coefficient values.

#### Example: Polynomial function file content

```
# Rohde & Schwarz - IQ Output Envelope Shaping Table
# a0,a1,a2,...
0.135,0.91,0.34,-0.59,-0.11
```

### 3.2.3.4 About the Shaping Table

The envelope shaping table is a widely used method to define the shaping function. This kind of definition is suitable if you have knowledge on or aim to achieve an exact relation between supply voltage and RF input power. For example, with suitable settings, the shaping table can precisely describe the transition region of the PA.

You can receive information on suitable envelope shaping values from the power amplifier manufacturer.

In the R&S SMW, there are two ways to define a shaping table function:

- **Externally**  
Create a shaping table file as a CSV file with Microsoft Excel, with a Notepad or a similar tool, save it with the predefined extension, transfer it to and load it into the instrument.  
See also ["File format of the shaping table file"](#) on page 16.
- **Internally**  
Use the built-in editor table editor, see [Chapter 3.6, "Edit I/Q Envelope Shape Settings"](#), on page 41.

#### File format of the shaping table file

The shaping table files are files with predefined extension and simple file format, see [Table 3-3](#).



**Table 3-3: Shaping table files: format and extensions**

"Envelope Voltage Adaptation"	File extension	Header (optional)
Auto Power	*.iq_lutpv	# Rohde & Schwarz - IQ Output Envelope Shaping Table # Power[dBm],Vcc[V]
Auto Normalized/Manual	*.iq_lut	# Rohde & Schwarz - IQ Output Envelope Shaping Table # Vin/Vmax,Vcc/Vmax

The header is optional. The file content is list of up to 4000 comma-separated value pairs; a new line indicator separates the pairs.

**Example: Shaping table file content (\*.iq\_lut file)**

```
# Rohde & Schwarz - IQ Output Envelope Shaping Table
# Vin/Vmax,Vcc/Vmax
0.3,0.4
0.35,0.45
0.56,0.55
0.4,0.5
0.6,0.65
0,0.135
```

**3.2.3.5 Shaping Function in Raw Data Format**

The shaping values are defined directly, with a single remote control command. You define the up to 4000 comma-separated value pairs, describing the Vin/Vmax,Vcc/Vmax OR Power[dBm],Vcc[V].

**Example:**

```
SOURce1:OUTPut:ANALog:ENVELOpe:SHAPing:PV:FILE:DATA 0,0, 0.1,0.2, 1,1
```

See:

- [:SOURce<hw>]:IQ:OUTPut[:ANALog]:ENVELOpe:SHAPing:FILE:DATA on page 96
- [:SOURce<hw>]:IQ:OUTPut[:ANALog]:ENVELOpe:SHAPing:PV:FILE:DATA on page 96
- [:SOURce<hw>]:IQ:OUTPut[:ANALog]:ENVELOpe:SHAPing:FILE:NEW on page 96
- [:SOURce<hw>]:IQ:OUTPut[:ANALog]:ENVELOpe:SHAPing:PV:FILE:NEW on page 96

**3.2.3.6 Converting Shaping Functions and Understanding the Displayed Values**

If an envelope function is defined, the "Shaping" dialog displays the diagram of the resulting envelope shape (see for example [Figure 3-7](#)).

Several parameters influence the displayed information:

- The selected "Envelope Voltage Adaptation" determines whether the x-axis uses normalized or linear values
- The selected "Graphic Configuration > Scale" sets the x-axis units
- The selected  $V_{ccMin}/Max$  and  $PEP_{inMin}/Max$  values set the borders of the clipping areas
- The selected "Shaping" function and the parameters influence the envelope shape.

The illustration on [Figure 3-2](#) shows how these parameters influence a linear shaping function.

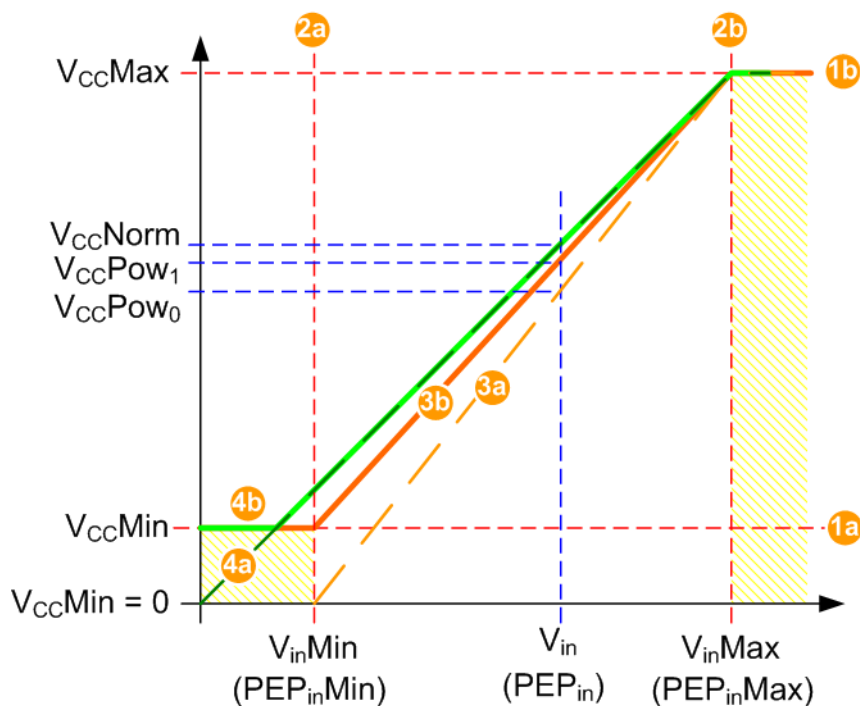

**Figure 3-2: Understanding the displayed values ("Shaping > Linear (Voltage)")**

Shaded area = Area where the signal is clipped and the envelope signal is held constant

1a, 1b, 2a, 2b =  $V_{cc,min}/V_{cc,max}$  and  $PEP_{inMin}/Max$  values that set the borders of the clipping areas

Shaping = Linear (Voltage)

3a = Linear function (dashed line) in "Auto Power" mode, if  $V_{cc,min} = 0$  V

3b = Linear function in "Auto Power" mode, if  $V_{cc,min} > 0$  V

4a = Linear function (dashed line) in "Auto Normalized" mode, if  $V_{cc,min} = 0$  V

4b = Linear function in "Auto Normalized" mode, if  $V_{cc,min} > 0$  V

$V_{in}$  = Operating point

$V_{cc}Norm$  =  $V_{cc}$  in "Auto Normalized" mode

$V_{cc}Pow_0$  =  $V_{cc}$  in "Auto Power" mode and  $V_{cc,min} = 0$  V

$V_{cc}Pow_1$  =  $V_{cc}$  in "Auto Power" mode and  $V_{cc,min} > 0$  V

For information on the provided shaping functions and their formulas, see:

- [Chapter 3.2.3.1, "About the Linear Functions"](#), on page 14
- [Chapter 3.2.3.2, "About the Detrouching Function"](#), on page 15
- [Chapter 3.2.3.3, "About the Polynomial Function"](#), on page 15

The group of examples in this section uses the same linear shaping function to explain the representation in the different voltage adaptation modes. The example explains the displayed values and how they are calculated and converted. The same principle applies for the other shaping methods.

### Common settings

- "Envelope Voltage Adaptation > Auto Power"
- $V_{cc,max} = 1 \text{ V}$
- $PEP_{in,Min} = -30 \text{ dBm}$  corresponds to  $V_{in,min} = 0.0071 \text{ V}$
- $PEP_{in,Max} = 0 \text{ dBm}$  corresponds to  $V_{in,max} = 0.2236 \text{ V}$
- $P_{in} = -15 \text{ dBm}$  corresponds  $V_{in} = 0.04 \text{ V}$
- $PEP = -3.4 \text{ dB}$
- "Shaping > Linear (Voltage)"

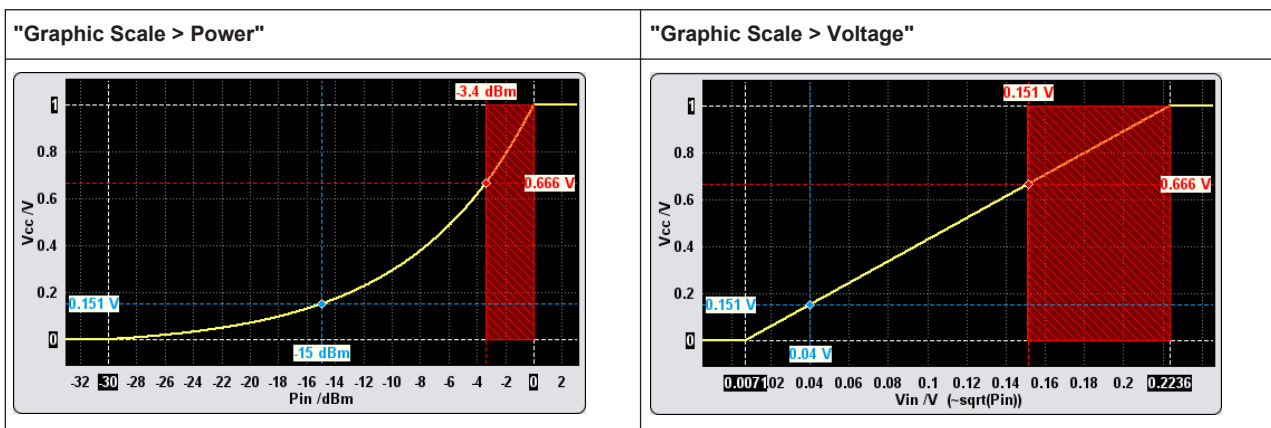

### Example: Calculating the current $V_{cc}Pow_0$ ("Auto Power" mode, $V_{cc,min} = 0 \text{ V}$ )

Configuration as described in [Common settings](#) and:

- $V_{cc,min} = 0 \text{ V}$
- $f(x) = b \cdot x + V_{cc,min}$   
(see [Chapter 3.2.3.1, "About the Linear Functions"](#), on page 14)

$$V_{cc}Pow_0 = [(V_{cc,max} - V_{cc,min}) / (V_{in,max} - V_{in,min})] \cdot (V_{in} - V_{in,min}) + V_{cc,min}$$

$$V_{cc}Pow_0 = [(1 - 0) / (0.2236 - 0.0071)] \cdot (0.04 - 0.0071) + 0$$

$$V_{cc}Pow_0 = 0.151 \text{ V}$$

**Example: Calculating the current  $V_{cc}Pow_1$  ("Auto Power" mode,  $V_{cc,min} > 0 V$ )**

Configuration as described in [Common settings](#) and:

- $V_{cc,min} = 200 mV$

$$V_{cc}Pow_1 = [(V_{cc,max} - V_{cc,min}) / (V_{in,max} - V_{in,min})] * (V_{in} - V_{in,min}) + V_{cc,min}$$

$$V_{cc}Pow_1 = [(1 - 0.2) / (0.2236 - 0.0071)] * (0.04 - 0.0071) + 0.2$$

$$V_{cc}Pow_1 = 0.321 V$$

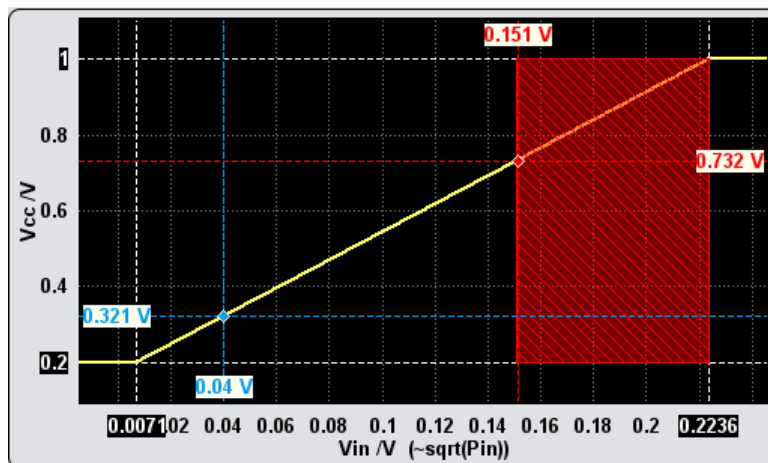

**Example: Calculating the current  $V_{cc} Norm$  ("Auto Normalized" mode)**

Configuration as described in [Common settings](#) and:

- "Envelope Voltage Adaptation > Auto Normalized"
- The x-axis shows the normalized values  $V_{in} / V_{in,max}$ ;  
The operating point with  $V_{in} = 0.04 V$  corresponds to  $V_{in} / V_{in,max} = 0.04 / 0.2236 = 0.178$

- $f(x) = x$ , i.e.  
 $V_{cc} Norm = V_{in} / V_{in,max}$   
 $V_{cc} Norm = 0.178 V$

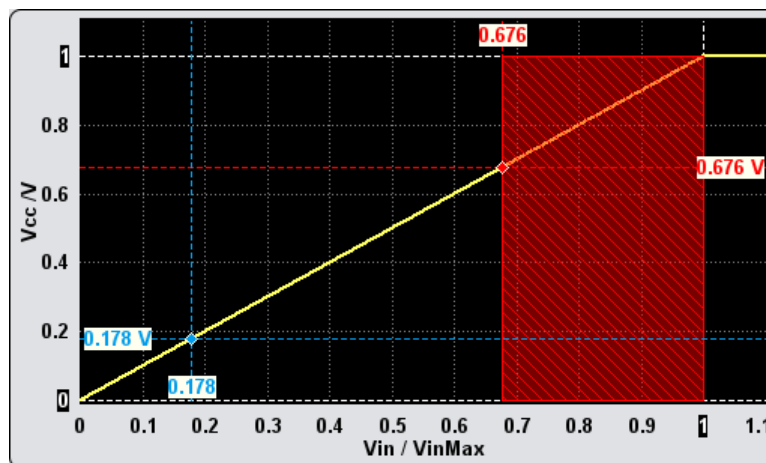

If the  $V_{cc,min}$  value is changed ( $V_{cc,min} > 0$  V), then the following applies:

- If  $0 < V_{in}/V_{in,max} \leq V_{cc,min}$ , the signal is clipped and  $V_{cc, Norm} = V_{cc,min}$
- If  $V_{in}/V_{in,max} > V_{cc,min}$ , then  $V_{cc, Norm} = V_{in}/V_{in,max}$

For the previous example, if  $V_{cc,min} = 200$  mV, that  $V_{cc, Norm} = V_{cc,min} = 0.2$  V.

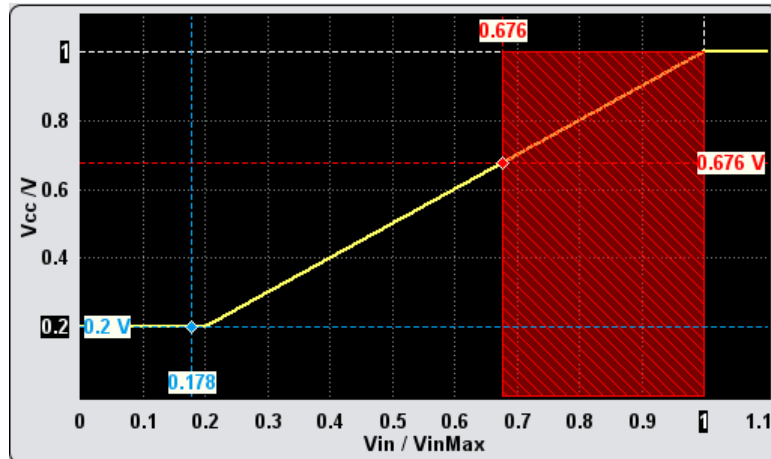

#### Example: Calculating the current $V_{CC}$ in "Manual" mode

In "Envelope Voltage Adaptation > Manual" mode, set the parameter "Pre-Gain = PEP = -3.4 dB".

The displayed shaping function resembles the shaping function in "Auto Normalized" mode; the same formulas apply, too.

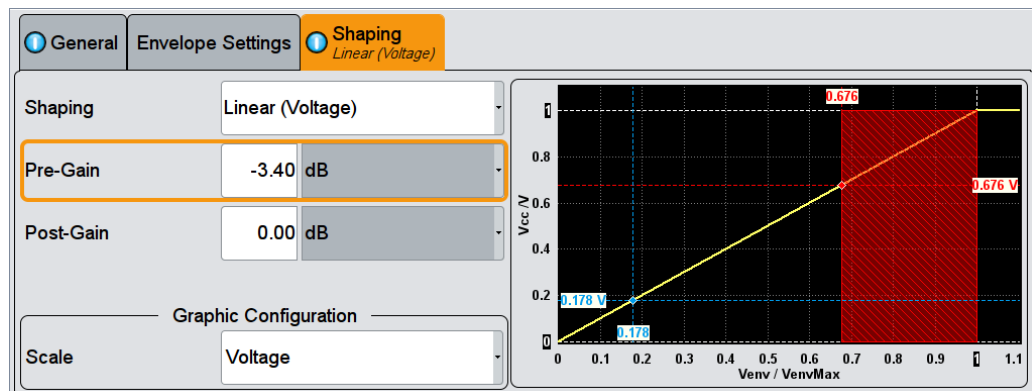

You can also query the  $V_{CC}$  values for any specified  $x$  in the supported voltage adaptation mode and units.

See [\[:SOURCE<hw>\]:IQ:OUTPut\[:ANALog\]:ENVELOpe:VCC:VALue?](#) on page 93.

#### Additional information

The described principle applies for any shaping function.

Only if linear shaping is used, the  $V_{CCNorm}$  can also be directly converted to  $V_{CCPow}$  according to the following formula:

$$f_{Pow}(x) = [f_{Norm}(x) - V_{in,min}/V_{in,max}] * [(V_{cc,max} - V_{cc,min}) / (1 - V_{in,min}/V_{in,max})]$$

For example, if  $f_{Norm}(x) = V_{CCNorm} = 0.178$  V,  $f_{Pow}(x) = V_{CCPow_0}$  is:

$$V_{CCPow_0} = [0.178 - 0.0071/0.2236] * [(1 - 0) / (1 - 0.0071/0.2236)]$$

$$V_{CCPow_0} = 0.151$$
 V

### 3.3 General RF Envelope Settings

To access the related settings and enable the generation of the envelope signal

1. In the block diagram, select the "I/Q OUT 1/2" connector to unfold the "I/Q Analog" block.
2. Select "I/Q Analog > I/Q Analog Settings > General".
3. Select "RF Envelope > On".
4. Select "I/Q Output Type > Differential".
5. Select "Envelope Voltage Adaptation > Auto Power".

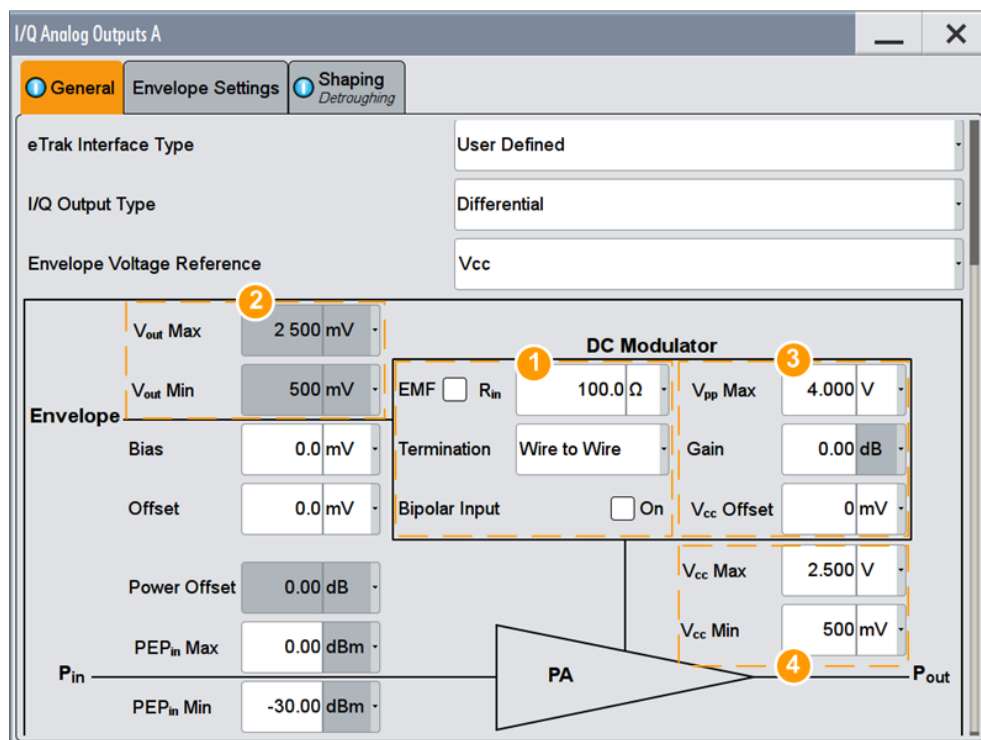

Figure 3-3: RF Envelope Settings (Example)

- 1 = Termination and input impedance of the circuit board
- 2 = Voltage level measured at the circuit board
- 3 = Signal characteristics of the DC Modulator
- 4 = Signal characteristics at the inputs of the PA (see the documentation of the PA, for example its data sheet)

The dialog displays a block diagram with parameters, necessary to configure the envelope signal.

- State..... 23
- Set to Default..... 23
- Save/Recall..... 24
- RF Envelope..... 24
- Envelope Voltage Adaptation..... 24
- eTrak® Interface Type..... 25
- Envelope Voltage Reference..... 25
- I/Q Output Type..... 25
- V<sub>out</sub>Min/Max..... 25
- Bias..... 26
- Offset..... 26
- DC Modulator characteristics..... 27
  - L EMF..... 27
  - L R<sub>in</sub>..... 27
  - L Termination..... 27
  - L Bipolar Input..... 28
  - L V<sub>pp</sub>Max..... 29
  - L Gain..... 29
  - L V<sub>cc</sub>Offset..... 29
- PA characteristics..... 29
  - L V<sub>cc</sub>Min/Max..... 30
  - L Power Offset..... 30
  - L PEP<sub>in</sub>Min/Max..... 30

**State**

Enables/disables the analog I/Q output.

**Note:** By default, these output connectors are deactivated.

Remote command:

```
[ :SOURce<hw> ] :IQ:OUTPut:ANALog:STATe on page 81
```

**Set to Default**

Calls the default settings. The values of the main parameters are listed in the following table.

Parameter	Value
"State"	Not affected by the "Set to Default"
"RF Envelope"	Off
"I/Q Output Type"	Single Ended

Parameter	Value
"I/Q Level Vp (EMF)"	1 V
"Bias (EMF)"	0 V

Remote command:

[\[:SOURce<hw>\]:IQ:OUTPut\[:ANALog\]:PRESet](#) on page 81

### Save/Recall

Accesses the "Save/Recall" dialog, that is the standard instrument function for storing and recalling the complete dialog-related settings in a file. The provided navigation possibilities in the dialog are self-explanatory.

The file name and the directory, in which the settings are stored, are user-definable; the file extension is however predefined.

See also, chapter "File and Data Management" in the R&S SMW user manual.

Remote command:

[\[:SOURce<hw>\]:IQ:OUTPut\[:ANALog\]:SETTing:CATalog?](#) on page 81

[\[:SOURce<hw>\]:IQ:OUTPut\[:ANALog\]:SETTing:STORE](#) on page 82

[\[:SOURce<hw>\]:IQ:OUTPut\[:ANALog\]:SETTing:LOAD](#) on page 82

[\[:SOURce<hw>\]:IQ:OUTPut\[:ANALog\]:SETTing:DELeTe](#) on page 82

### RF Envelope

In instruments equipped with option R&S SMW-K540, enables the output of a control signal that follows the RF envelope. This control signal is provided for power amplifiers envelope tracking testing. The signal is output at the I OUT and I BAR OUT connectors.

See:

- [Chapter 3, "Generation of Envelope Tracking Signals"](#), on page 11
- [Chapter 5, "How to Generate a Control Signal for Power Amplifier Envelope Tracking Tests"](#), on page 70

Remote command:

[\[:SOURce<hw>\]:IQ:OUTPut\[:ANALog\]:ENVELOpe:STATe](#) on page 87

### Envelope Voltage Adaptation

In instruments equipped with option R&S SMW-K540, defines the way you configure the voltage of the envelope tracking generator (see [Chapter 3.2.1, "Envelope Voltage Adaptation Modes"](#), on page 12).

"Auto Normalized"

Generation based on the physical characteristics of the power amplifier; the power values are normalized based on the selected [PEPin Max](#) value.

This mode enables you to use the complete range of a selected detrouthing function.

See also [Shaping Settings](#) and compare the values on the X axis on the graphical display.



"Auto Power"      Generation based on the physical characteristics of the power amplifier, where the input power of the PA "PEP<sub>in</sub>" is defined with its min and max values.

"Manual"            Generation, in that the operating range of the amplifier is defined based on a pre-gain and a post-gain range.

Remote command:

`[ :SOURce<hw> ] :IQ:OUTPut [ :ANALog ] :ENVELOpe:ADAPtion` on page 87

### eTrak® Interface Type

Selects one of the predefined interface types or allows user-defined settings.

See Chapter 3.2.2, "Signal Parameters for Testing According to the eTrak® Specification", on page 13.

Remote command:

`[ :SOURce<hw> ] :IQ:OUTPut [ :ANALog ] :ENVELOpe:ETRak` on page 88

### Envelope Voltage Reference

Defines whether the envelope voltage  $V_{out}$  is set directly or it is estimated from the selected supply voltage  $V_{cc}$ .

Remote command:

`[ :SOURce<hw> ] :IQ:OUTPut [ :ANALog ] :ENVELOpe:VREF` on page 88

### I/Q Output Type

Selects the type of output signal.

The provided parameters in the dialog depend on the selected output mode.

"Differential"      • If "RF Envelope > On"  
The inverted envelope signal E BAR is output at the I BAR OUT connectors.  
• If "RF Envelope > Off"  
The analog I/Q signal components are output at the I/Q BAR OUT connectors.

"Single Ended"    • If "RF Envelope > On"  
The envelope signal E is output at the I OUT connectors.  
• If "RF Envelope > Off"  
Single ended output at the I/Q OUT connectors.

You can define a bias between the output signal and ground.

Remote command:

`[ :SOURce<hw> ] :IQ:OUTPut [ :ANALog ] :TYPE` on page 82

### $V_{out}$ Min/Max

Sets or displays the minimum and maximum values of the peak-to-peak voltage  $V_{out}$  voltage on the interface between the circuit board and the DC modulator.

To measure the  $V_{out}$  voltage:

- Use a suitable probe, i.e. use a differential probe if a "Wire to Wire" termination is used and a single ended probe otherwise
- Measure at the circuit board after the termination impedance  $R_{in}$ .

If estimated, the "V<sub>out</sub>Min/Max" values are calculated based on the selected supply voltage V<sub>cc</sub>Min/Max and enabled Gain and V<sub>cc</sub>Offset in the DC modulator.

Remote command:

`[ :SOURce<hw> ] :IQ:OUTPut [ :ANALog ] :ENVELOpe:VOUT:MIN` on page 89

`[ :SOURce<hw> ] :IQ:OUTPut [ :ANALog ] :ENVELOpe:VOUT:MAX` on page 89

**Bias**

If a bias is enabled, a DC voltage is superimposed upon the envelope signal E and the inverted envelope signal E BAR.

"I/Q Output Type"	Termination	"Bias" defines
Single Ended	-	The bias between the envelope signal E and ground
Differential	"To Ground"	Superimposed DC voltage = "Bias", where "Bias" is related to the selected R <sub>in</sub> . See also Table 3-4
	"Wire To Wire"	Superimposed DC voltage = "Bias", where "Bias" is related to high impedance (1 MΩ).

Table 3-4: Effect of enabled bias

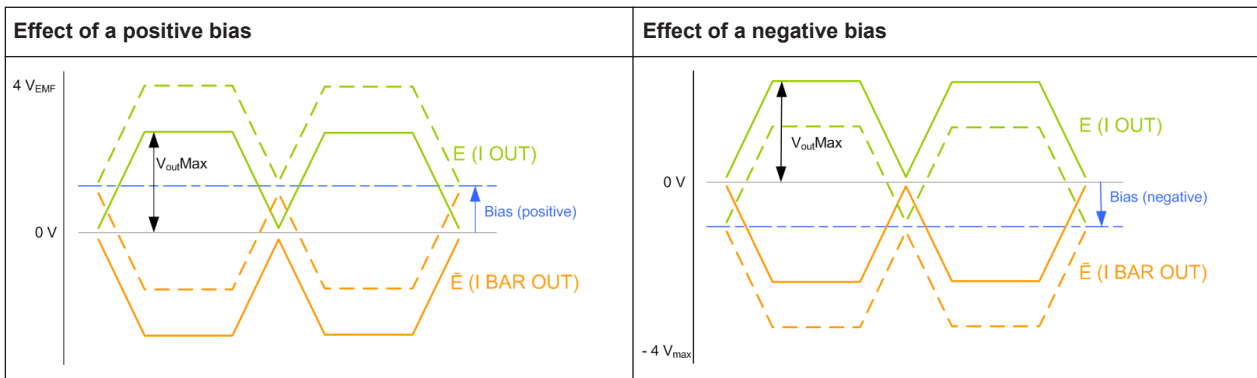

Use this parameter to define the operating point of a DUT.

Remote command:

`[ :SOURce<hw> ] :IQ:OUTPut [ :ANALog ] :ENVELOpe:BIAS` on page 89

**Offset**

Sets an offset between the envelope and the inverted envelope signal.

The value range is dynamically adjusted.

The selected offset is set half in the positive and half in the negative direction.

Table 3-5: Effect of an enabled envelope offset

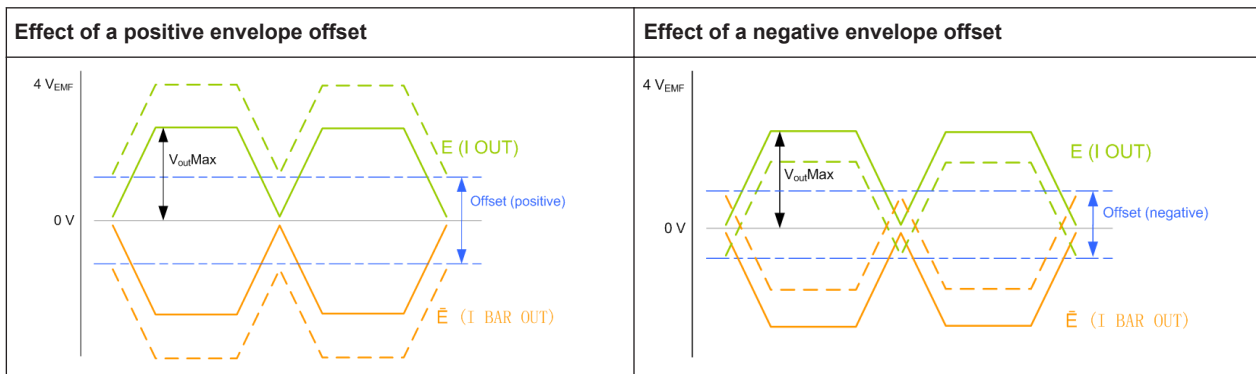

See also "[V<sub>cc</sub>Offset](#)" on page 29.

Remote command:

[\[:SOURce<hw>\]:IQ:OUTPut\[:ANALog\]:ENVELOpe:OFFSet](#) on page 89

### DC Modulator characteristics

Refer to the product documentation of the external DC modulator for information on its characteristics.

The following settings are required:

#### EMF ← DC Modulator characteristics

Defines whether the EMF or the voltage value is displayed.

An EMF-based calculation assumes an open-end circuit. Disable this parameter for testing in more realistic conditions, where you define the input impedance of the used external DC modulator  $R_{in}$  and the instrument calculates the envelope output voltage  $V_{outMin/Max}$  based on it.

Remote command:

[\[:SOURce<hw>\]:IQ:OUTPut\[:ANALog\]:ENVELOpe:EMF\[:STATe\]](#) on page 90

#### $R_{in}$ ← DC Modulator characteristics

With disabled parameter [EMF](#), sets the input impedance  $R_{in}$  of the used external DC modulator.

Remote command:

[\[:SOURce<hw>\]:IQ:OUTPut\[:ANALog\]:ENVELOpe:RIN](#) on page 90

#### Termination ← DC Modulator characteristics

If the "[I/Q Output Type](#) > Differential", defines the way the inputs of the DC modulator are terminated.

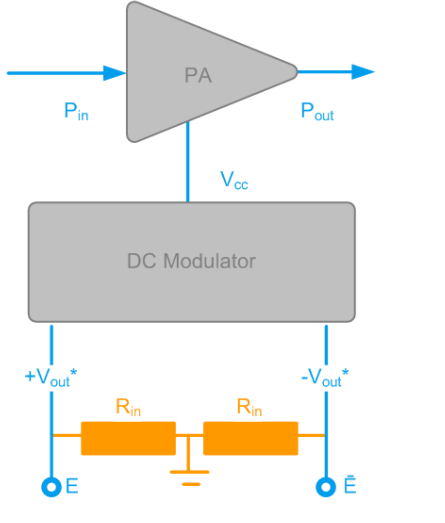
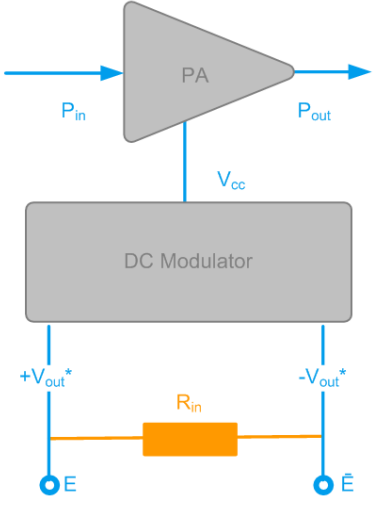
"To Ground"	"Wire to Wire"
 <p data-bbox="403 891 643 918">*) Bias = 0 and Offset = 0</p>	 <p data-bbox="922 891 1161 918">*) Bias = 0 and Offset = 0</p>
<p>Both inputs of the DC modulator are terminated to ground.</p>	<p>This termination is also referred as a common mode voltage.</p>

The termination influences the way an enabled Bias is applied.

Remote command:

```
[ :SOURce<hw> ] :IQ:OUTPut [ :ANALog ] :ENVELOpe:TERMINation on page 90
```

**Bipolar Input ← DC Modulator characteristics**

If the "I/Q Output Type > Differential", enables the instrument to generate a bipolar signal.

The envelope signal E swings above and below the inverted envelope signal E BAR; the R&S SMW calculates and applies a suitable envelope Offset automatically, see Figure 3-4.

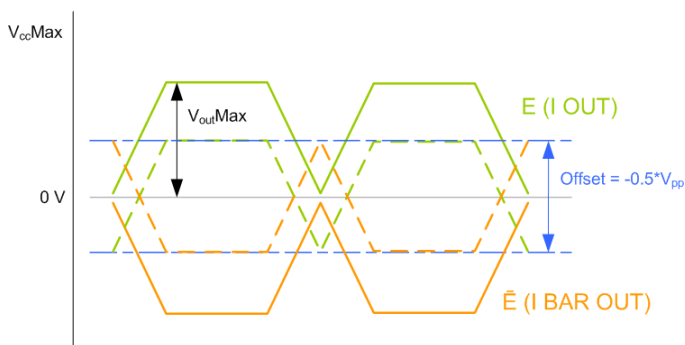

Figure 3-4: Effect of a "Bipolar Input > On"

This parameter influences the lower limit of the supply voltage Vcc.

The generated signal is conform with the MIPI®Alliance specification "Specification for Analog Reference Interface for Envelope Tracking".

Remote command:

`[ :SOURce<hw> ] :IQ:OUTPut [ :ANALog ] :ENVELOpe:BINPut` on page 91

#### **$V_{pp}Max$ ← DC Modulator characteristics**

Sets the maximum value of the peak-to-peak driving voltage  $V_{pp}$  of the used external DC modulator.

The  $V_{pp}$  limits:

- The value range of the supply voltage  $V_{cc}Min/Max$   
 $V_{pp} \geq V_{cc}Max$
- In **I/Q Output Type** > Differential, the voltage of the generated envelope signal  $V_{out}Min/Max$  as follows:  
 $V_{pp} \geq V_{out}Max[E] - V_{out}Max[E \text{ BAR}]$ , where [E] and [E BAR] refer to the envelope signal and the inverted envelope signal.

Remote command:

`[ :SOURce<hw> ] :IQ:OUTPut [ :ANALog ] :ENVELOpe:VPP [ :MAX ]` on page 90

#### **Gain ← DC Modulator characteristics**

Sets the gain of the used external DC modulator.

Remote command:

`[ :SOURce<hw> ] :IQ:OUTPut [ :ANALog ] :ENVELOpe:GAIN` on page 91

#### **$V_{cc}Offset$ ← DC Modulator characteristics**

Applies a voltage offset on the supply voltage  $V_{cc}Min/Max$ , i.e. compensates a possible offset from the external DC modulator. The envelope output voltage  $V_{out}Min/Max$  is reduced by this value to maintain the supply voltage  $V_{cc}$  in the defined value range.

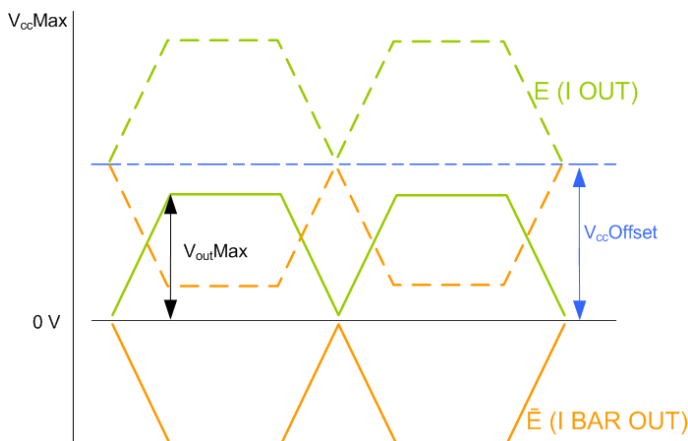

**Figure 3-5: Effect of a  $V_{cc}$  offset**

Remote command:

`[ :SOURce<hw> ] :IQ:OUTPut [ :ANALog ] :ENVELOpe:VCC:OFFSet` on page 91

#### **PA characteristics**

Refer to the product documentation of the PA for information on its characteristics.

The following settings are required:

**V<sub>cc</sub>Min/Max ← PA characteristics**

Sets or displays the minimum and maximum values of the supply voltage V<sub>cc</sub>, as required by the used power amplifier (PA).

The value range of the supply voltage V<sub>cc</sub> is determined by the allowed peak-to-peak driving voltage V<sub>pp</sub> of the used external DC modulator and the enabled V<sub>cc</sub>Offset.

$$V_{cc}Max \leq V_{pp}Max$$

The V<sub>cc</sub> is calculated as follows:

$$V_{cc} = V_{out} * Gain + V_{cc}Offset$$

**Example:**

Envelope Voltage Reference = V<sub>cc</sub>

V<sub>cc</sub>Offset = 0 mV

V<sub>cc</sub>Max = 1 V = 0 dBV

Gain = 3 dB

V<sub>cc</sub>Max [dBV] - Gain [dB] = V<sub>out</sub>Max or

V<sub>out</sub>Max = 0 dBV - 3 dB = -3 dBV = 0.708 V

"Bipolar Input"	Value range "V <sub>cc</sub> Min"
"State > On"	V <sub>cc</sub> Min = - 0.5*V <sub>pp</sub> Max <b>Note:</b> Implemented as a V <sub>cc</sub> Offset, see <a href="#">Figure 3-4</a> .
"State > Off"	V <sub>cc</sub> Min = 0 to V <sub>cc</sub> Max

Remote command:

`[ :SOURce<hw> ] :IQ:OUTPut [ :ANALog ] :ENVELOpe:VCC:MIN` on page 92

`[ :SOURce<hw> ] :IQ:OUTPut [ :ANALog ] :ENVELOpe:VCC:MAX` on page 92

**Power Offset ← PA characteristics**

Indicates an enabled power offset, for example to compensate power attenuation because of cable lengths.

The displayed value is applied as level offset to the generated RF signal and considers the following settings:

- "RF > RF Level > Level > Offset"
- "RF > RF Level > UCOR"

Remote command:

`[ :SOURce<hw> ] :IQ:OUTPut [ :ANALog ] :ENVELOpe:POWer:OFFSet?`  
on page 94

**PEP<sub>in</sub>Min/Max ← PA characteristics**

Sets the minimum and maximum values of the input power PEP<sub>in</sub>, as required by the used power amplifier (PA).

The "PEP<sub>in</sub>Min/Max" parameters define the linear range of the PA. Refer to the product documentation of the PA for information on the characteristics of the required input signal.

The value range corresponds to the value range of output level.

Remote command:

[ :SOURce<hw> ] : IQ:OUTPut [ :ANALog ] : ENVELOpe: PIN: MIN on page 93

[ :SOURce<hw> ] : IQ:OUTPut [ :ANALog ] : ENVELOpe: PIN: MAX on page 93

### 3.4 Envelope Settings

The envelope tracking is a feature that requires the additional option R&S SMW-K540.

#### To access the envelope settings

1. Enable the generation of envelope tracking signal, see "[To access the related settings and enable the generation of the envelope signal](#)" on page 22.
2. Select "I/Q Analog Settings > Envelope Settings".

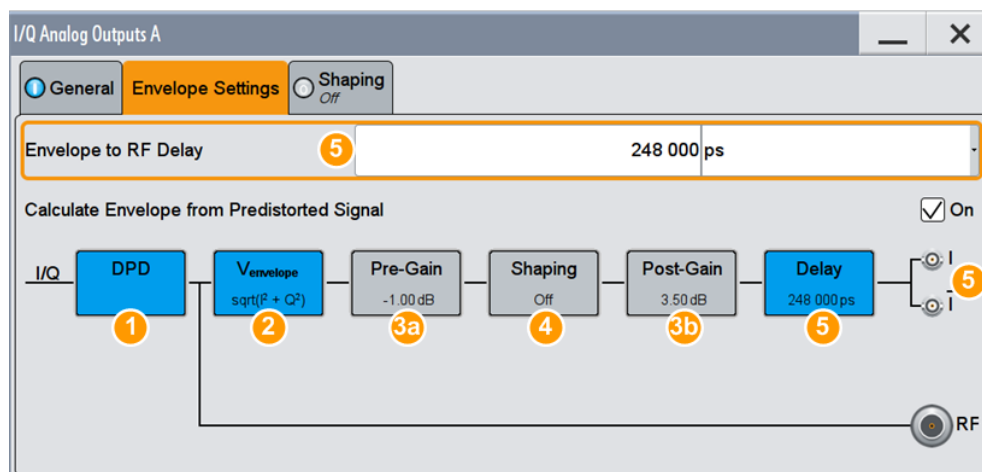

- 1 = Enabled [Digital Predistortion](#)
- 2 = Envelope detector,  $\sqrt{|I(t)|^2 + |Q(t)|^2}$ ; indication changes, depending on the [Envelope Voltage Adaptation](#)
- 3a, 3b = [Pre-Gain/Post-Gain](#) (available in "Envelope Voltage Adaptation > Manual" mode)
- 4 = [Shaping](#) state and shaping function; grey background color = deactivated shaping
- 5 = Enabled [Envelope to RF Delay](#)
- 6 = Indicates the output connectors, depending on the [I/Q Output Type](#)

The dialog displays an *interactive* overview diagram of the ET processing chain. The diagram displays information on shaping state, incl. current shaping method and setting, like gains or delay.

**Tip:** Hotspots for quick access. The displayed blocks are hotspots. Select one of them to access the related function.

3. To shape the envelope signal, perform one of the following:
  - a) on the overview diagram, select the "Shaping" block

b) select "I/Q Analog Settings > Shaping"

See Chapter 3.5, "Shaping Settings", on page 33.

Envelope to RF Delay..... 32

Calculate Envelope form Predistorted Signal..... 32

**Envelope to RF Delay**

Sets the time delay of the generated envelope signal relative to the corresponding RF signal. A positive value means that the envelope signal delays relative to the RF signal and vice versa.

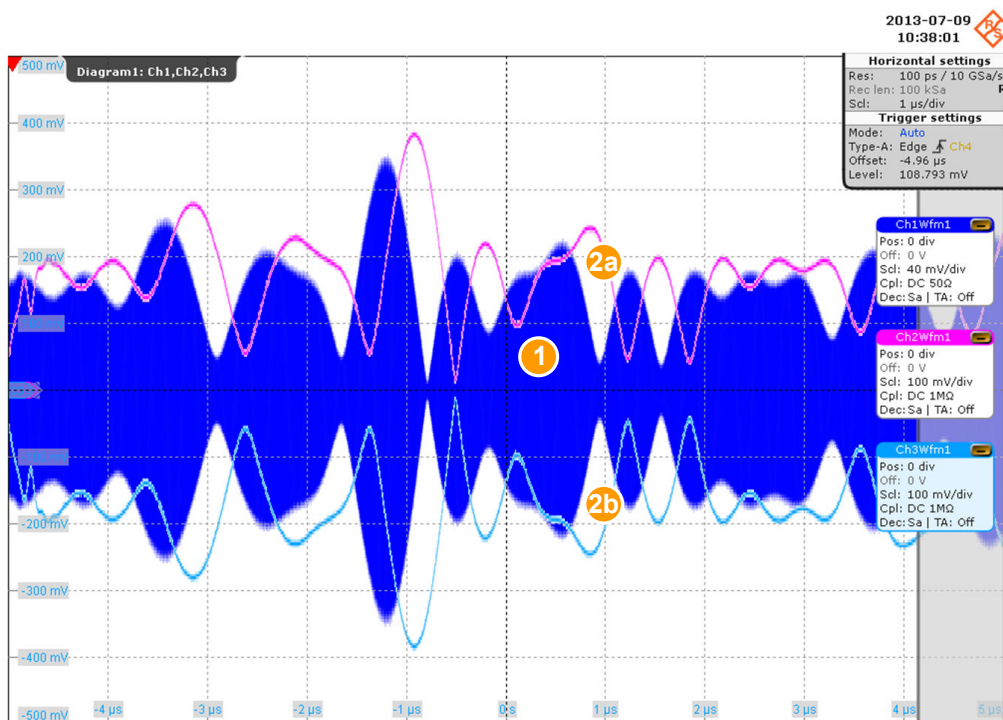

**Figure 3-6: Effect of enabled positive RF delay**

- 1 = RF signal
- 2a, 2b = Envelope signal E and inverted envelope signal E BAR

Use this parameter to compensate possible timing delays caused by connected cables and align the input signals at the PA to prevent unwanted effects, like memory effects or decreased linearity.

Remote command:

`[ :SOURce<hw> ] :IQ:OUTPut [ :ANALog ] :ENVelope:DELay` on page 88

**Calculate Envelope form Predistorted Signal**

In instruments equipped with option R&S SMW-K541, enables the calculation of the envelope signal from the original baseband signal or from the AM/AM and/or AM/FM predistorted signal.

See also Chapter 4, "Applying Digital Predistortion", on page 46.



Remote command:

[ :SOURce<hw> ] :IQ:OUTPut [ :ANALog ] :ENVELOpe:FDPD on page 88

### 3.5 Shaping Settings

The envelope tracking is a feature that requires the additional option R&S SMW-K540.

**To access the shaping settings in "Envelope Voltage Adaptation > Auto Power/Normalization" mode**

1. Select "I/Q Analog > I/Q Analog Settings > General".
2. Enable "RF Envelope > On".
3. Enable "Envelope Voltage Adaptation > Auto Power/Normalization".
4. Select "I/Q Analog Settings > Shaping".

With the provided settings, you can configure the shape of the RF envelope signal. The instrument applies the settings and calculates the shaping function. A diagram visualizes the resulting envelope shape, as function of the selected supply voltage  $V_{cc}$  and  $PEP_{in}$  value limits, the calculated pre-gain and the estimated operating point of the PA.

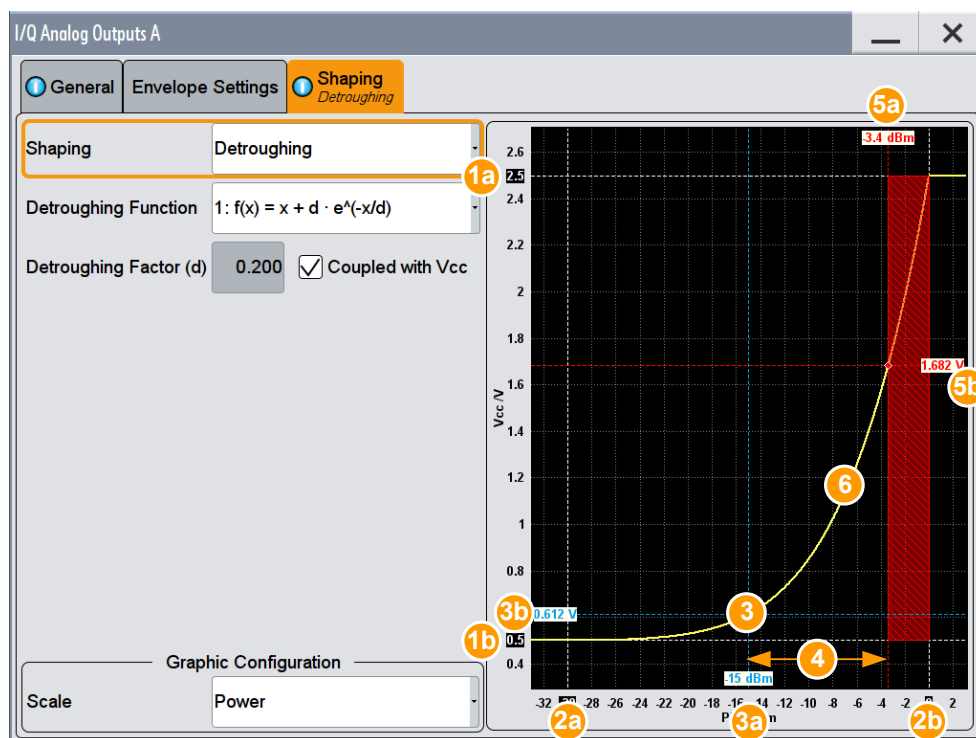

Figure 3-7: Understanding the displayed information ("Envelope Voltage Adaptation > Auto Power", "Shaping > Detrouging")

- 1a, 1b = Indicates the values of  $V_{CC}Min/Max$
- 2a = Values smaller than  $PEP_{in}Min$  are clipped
- 2b = Values greater than  $PEP_{in}Max$  are clipped
- 3 = Operating point; corresponds to the RF RMS power level
- 3a = Current RF RMS power level; an enabled "RF Level > Level Offset" is considered
- 3b = Current  $V_{CC}$
- 4 = Crest factor of the generated signal
- 5a, 5b = The values correspond to the PEP of the generated RF signal and the  $V_{CC}$ ; shaded area indicates the calculated **Pre-Gain**
- 6 = Current envelope shape, defined by the detrouthing function and detrouthing factor

See also:

- [Chapter 5, "How to Generate a Control Signal for Power Amplifier Envelope Tracking Tests"](#), on page 70.
- [Chapter 3.2.3.6, "Converting Shaping Functions and Understanding the Displayed Values"](#), on page 17.

Provided are the following settings:

Shaping.....	34
Detrouthing Function.....	38
Couple Detrouthing Factor with Vcc.....	38
Detrouthing Factor (d).....	39
Exponent (a).....	39
Pre-Gain.....	39
Post-Gain.....	39
Polynomial Coefficients.....	39
Shaping Table.....	39
Interpolation.....	40
Graphic Configuration.....	40
L Scale.....	41
L Diagram.....	41

### Shaping

Enables envelope shaping and selects the method to define the shaping function.

For detailed information on the shaping functions, see:

- [Chapter 3.2.3, "Envelope Shaping and Shaping Methods"](#), on page 13
- [Chapter 3.2.3.6, "Converting Shaping Functions and Understanding the Displayed Values"](#), on page 17.

See also [Chapter 5, "How to Generate a Control Signal for Power Amplifier Envelope Tracking Tests"](#), on page 70

"Off"

Envelope shaping is not adopted. Previously configured values of the parameters **Pre-Gain** and **Post-Gain** are ignored.

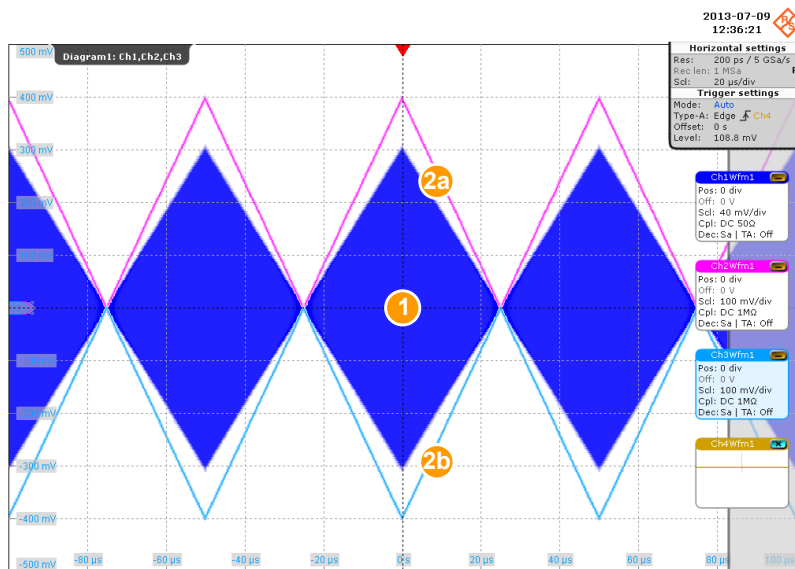

**Figure 3-8: Generated RF, envelope and inverted envelope signal**

- 1 = RF signal (simple ramp function)
- 2a, 2b = Envelope signal E and inverted envelope signal E BAR

"Linear (Voltage)/Linear (Power)"

The shaping function is simple linear function. The linear shaping is not used in practice but can be used for less demanding applications, simple analysis, and the first interactions by designing the optimum envelope shape. Because the shaping gain of the linear function is 0 dB, in "Envelope Voltage Adaptation > Manual" mode this function is suitable for determining the "Pre-/Post-Gain" values.

"Detroughing" The shaping function applies a detroughing to prevent that the supply voltage  $V_{cc}$  drops down to zero.  
 Use the **Detroughing Factor (d)** to limit the supply voltage  $V_{cc}$  in the low-power region.

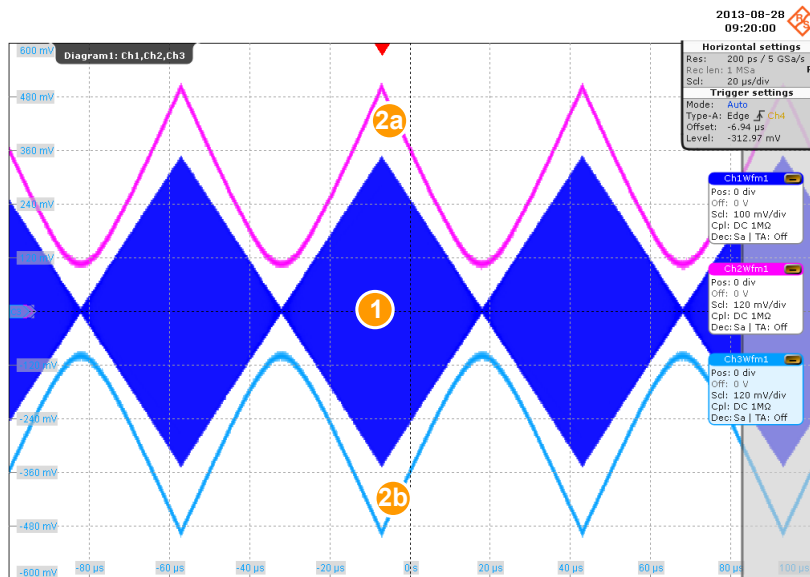
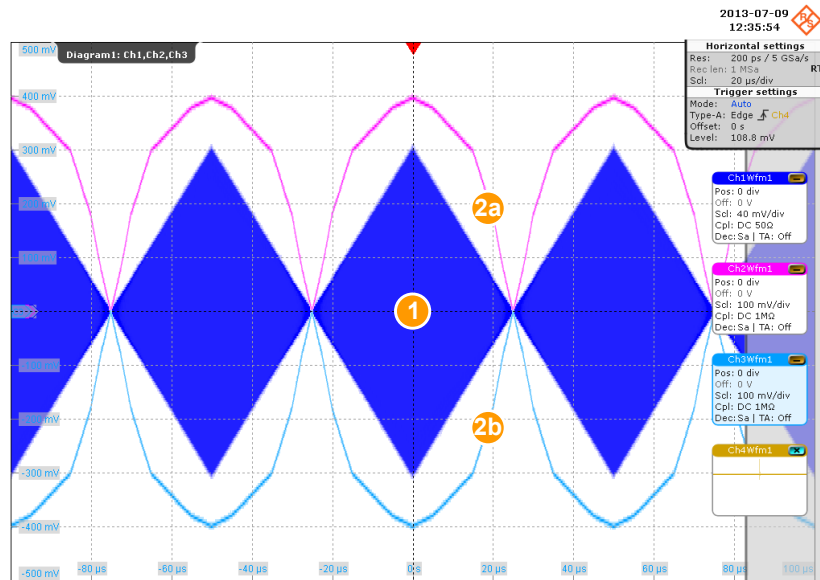

**Figure 3-9: Effect of a detroughing function on the envelope and inverted envelope signal**

- 1 = RF signal (simple ramp function)
- 2a, 2b = Envelope signal E and inverted envelope signal E BAR

"From Table" The shaping function is defined by user defined value pairs in form of a shaping table.

This shaping function is suitable if you have knowledge on or aim to achieve an exact relation between the supply voltage and RF output power, for example by the describing the transition region of a PA. Select [Shaping Table](#) to access the settings.

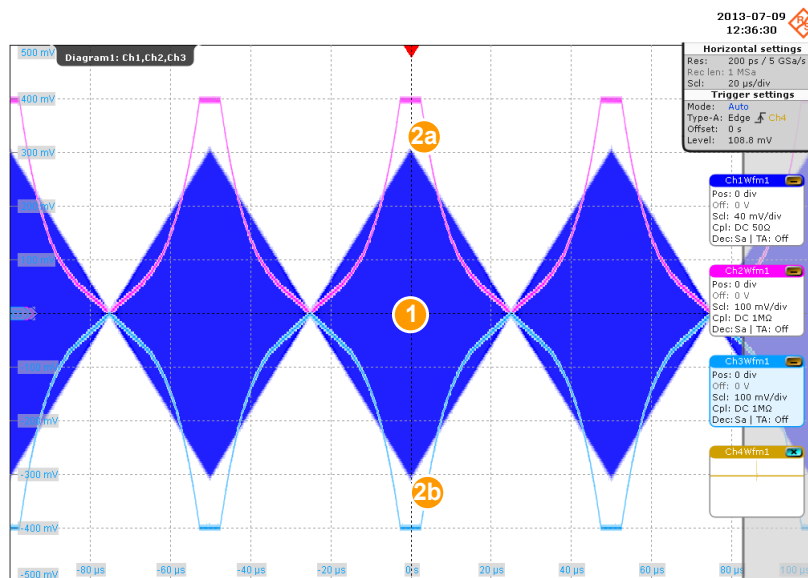

**Figure 3-10: Effect of a table shaping on the envelope and inverted envelope signal**

1 = RF signal (simple ramp function)

2a, 2b = Envelope signal E and inverted envelope signal E BAR

"Polynomial" The shaping function is defined by a polynomial with configurable order and coefficients.  
Select [Polynomial Coefficients Setting](#) to access the settings.



**Figure 3-11: Effect of a polynomial shaping on the envelope and inverted envelope signal**

1 = RF signal (simple ramp function)

2a, 2b = Envelope signal E and inverted envelope signal E BAR

Remote command:

`[ :SOURce<hw> ] :IQ:OUTPut [ :ANALog ] :ENVELOpe:SHAPing:MODE` on page 94

### Detrouching Function

Selects the mathematical function describing the detrouching.

The following functions are available:

- $f(x) = x + d \cdot e^{-x/d}$
- $f(x) = 1 - (1 - d) \cdot \cos(x \cdot \pi/2)$
- $f(x) = d + (1 - d) \cdot x^a$

where:

- x depends on the "Envelope Voltage Adaptation" mode, see [Table 3-2](#)
- d = [Detrouching Factor \(d\)](#)
- a = [Exponent \(a\)](#)

For more information, see [Chapter 3.2.3.6, "Converting Shaping Functions and Understanding the Displayed Values"](#), on page 17.

Remote command:

`[ :SOURce<hw> ] :IQ:OUTPut [ :ANALog ] :ENVELOpe:SHAPing:DETRoughing:FUNCTion` on page 98

### Couple Detrouching Factor with Vcc

Enable this parameter to derive the detrouching factor (d) from the selected  $V_{CC}$  value. This ensures that the minimum supply voltage  $V_{CC}$  does not drop under the specified limits and the signal is not clipped.

The detrouthing factor is calculated as follows:

$$d = V_{ccMin}/V_{ccMax}$$

Remote command:

`[ :SOURce<hw> ] : IQ : OUTPut [ :ANALog ] : ENVELOpe : SHAPing : DETRoughing : COUPLing` on page 98

#### Detrouthing Factor (d)

Sets a start offset to limit the supply voltage  $V_{cc}$  in the low-power region.

The detrouthing factor also controls the shaping. A "Detrouthing Factor = 0" defines a linear function.

See also "[Couple Detrouthing Factor with Vcc](#)" on page 38.

Remote command:

`[ :SOURce<hw> ] : IQ : OUTPut [ :ANALog ] : ENVELOpe : SHAPing : DETRoughing : FACTor` on page 98

#### Exponent (a)

Sets the exponent (a) for the third detrouthing function, see [Detrouthing Function](#).

Remote command:

`[ :SOURce<hw> ] : IQ : OUTPut [ :ANALog ] : ENVELOpe : SHAPing : DETRoughing : PEXponent` on page 98

#### Pre-Gain

In "[Envelope Voltage Adaptation > Manual](#)" mode, sets a pre-gain (i.e. an attenuation) applied to define the operating range of the power amplifier. The pre-gain can be used to define and test only a specific (required) part of the operating range.

In "Envelope Voltage Adaptation > Auto" mode, the value is calculated automatically as following:

$$\text{"Pre-Gain"} = \text{"Pin max"} - \text{"RF Level"} + \text{Crest Factor}$$

Remote command:

`[ :SOURce<hw> ] : IQ : OUTPut [ :ANALog ] : ENVELOpe : SHAPing : GAIN : PRE` on page 95

#### Post-Gain

In "[Envelope Voltage Adaptation > Manual](#)" mode, sets a post-gain to compensate the attenuation introduced by the pre-gain and the gain of the shaping function.

Remote command:

`[ :SOURce<hw> ] : IQ : OUTPut [ :ANALog ] : ENVELOpe : SHAPing : GAIN : POST` on page 95

#### Polynomial Coefficients

Accesses a dialog to describe the envelope shape as a polynomials function, see [Chapter 3.7, "Polynomial Coefficients Setting"](#), on page 43.

#### Shaping Table

Accesses the standard "Envelope Select" dialog with functions to define a new shaping table file, select or edit an existing one.

The shaping table files are files with predefined extension and file format, see "File format of the shaping table file" on page 16.

You can create a shaping table externally or internally.

- "Select" Selects and loads an existing file
- "New" Creates a file
- "Edit" Access a standard built-in table editor, see Chapter 3.6, "Edit I/Q Envelope Shape Settings", on page 41.

Remote command:

In "Envelope Voltage Adaptation > Manual" mode:

`[ :SOURce<hw> ] :IQ:OUTPut [ :ANALog ] :ENVELOPE:SHAPing:FILE:CATalog?`  
on page 95

`[ :SOURce<hw> ] :IQ:OUTPut [ :ANALog ] :ENVELOPE:SHAPing:FILE[:SElect]`  
on page 95

In "Envelope Voltage Adaptation > Auto" mode:

`[ :SOURce<hw> ] :IQ:OUTPut [ :ANALog ] :ENVELOPE:SHAPing:PV:FILE:CATalog?` on page 95

`[ :SOURce<hw> ] :IQ:OUTPut [ :ANALog ] :ENVELOPE:SHAPing:PV:FILE[:SElect]` on page 95

**Interpolation**

Enabled in "Shaping > From Table".

An envelope shaping function defined in a table contains a limited number of value pairs. This parameter enables a linear interpolation between the defined values to prevent abrupt changes.

Table 3-6: Effect of parameter "Interpolation"

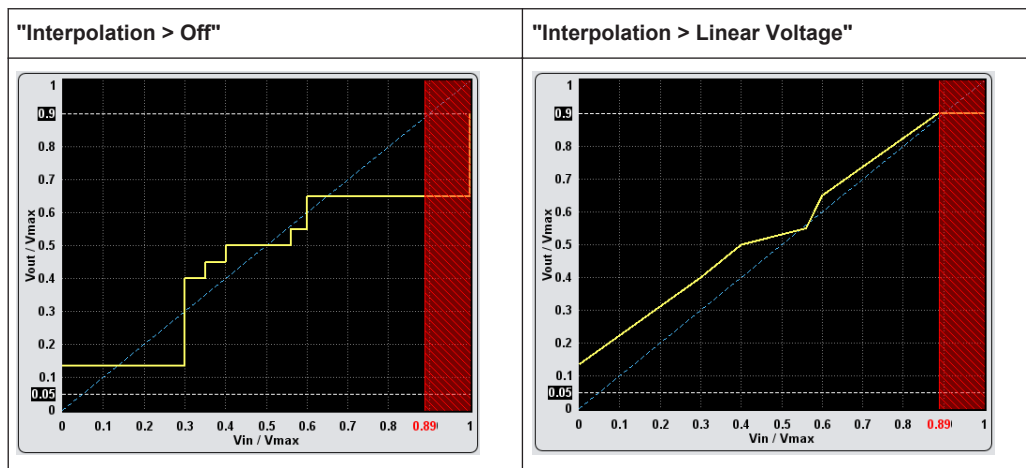

Remote command:

`[ :SOURce<hw> ] :IQ:OUTPut [ :ANALog ] :ENVELOPE:SHAPing:INTerp`  
on page 96

**Graphic Configuration**

Comprises setting to configure the graphical display.



**Scale ← Graphic Configuration**

Determines the units, "Voltage" or "Power", used on the x and y axis.

**Table 3-7: Units on the x axis**

	"Scale > Power"	"Scale > Voltage"
Envelope Voltage Adaptation > Auto Power	$P_{in}$ [dBm]	$V_{in}$ [V] = $\sqrt{P_{in}}$
Envelope Voltage Adaptation > Auto Normalized	$P_{in}/P_{max}$	$V_{in}/V_{max}$

Remote command:

`[ :SOURce<hw> ] :IQ:OUTPut [ :ANALog ] :ENVELOpe:SHAPing:SCALE`  
on page 94

**Diagram ← Graphic Configuration**

Visualizes the resulting envelope shape, as function of the selected supply voltage  $V_{cc}$  and  $PEP_{in}$  value limits, the calculated pre-gain and the estimated operating point of the PA.

See [Figure 3-7](#).

Remote command:

`[ :SOURce<hw> ] :IQ:OUTPut [ :ANALog ] :ENVELOpe:VCC:VALue:LEVEL?`  
on page 92

`[ :SOURce<hw> ] :IQ:OUTPut [ :ANALog ] :ENVELOpe:VCC:VALue:PEP?`  
on page 92

`[ :SOURce<hw> ] :IQ:OUTPut [ :ANALog ] :ENVELOpe:VCC:VALue?` on page 93

## 3.6 Edit I/Q Envelope Shape Settings

The envelope shaping table is a method to define the shaping function.

### To access the internal table editor

1. Select "I/Q Analog > I/Q Analog Settings > General".
2. Enable "RF Envelope > On".
3. Select "Envelope Voltage Adaptation > Manual".
4. Select "Shaping Settings > Shaping > From Table".
5. Select "Shaping Table > Envelope Shaping File > New"
6. Enter the "File Name", e.g. *MyLUT*  
The "Envelope Shaping File" dialog closes.  
The "Shaping > Shaping Table" confirms that the newly created file is assigned.
7. Select "Shaping Table > Envelope Shaping File > Edit"
8. Define the value pairs "Vin/Vmax" and "Vcc/Vmax". The order is uncritical.

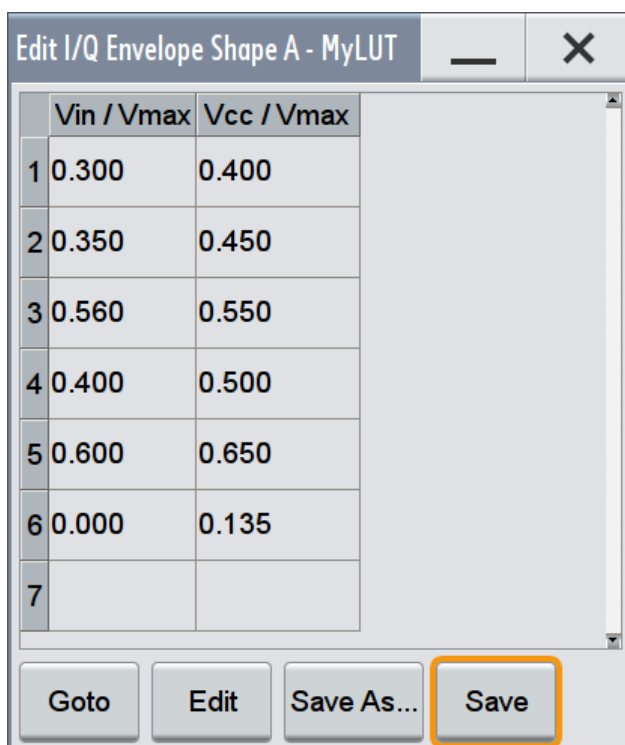

Figure 3-12: Shaping table in "Envelope Voltage Adaptation > Manual" mode

9. Select "Save".  
The instrument loads the configured values automatically and displays the shaping function.
10. Select "Shaping Settings > Interpolation > Linear (Voltage)".  
The display confirms the used interpolation.

Vin/Vmax, Vcc/Vmax / Power (dBm), Vcc (V).....	42
Goto, Edit, Save As, Save.....	42
Fill Table Automatically.....	43

**Vin/Vmax, Vcc/Vmax / Power (dBm), Vcc (V)**

Sets the normalized values of the value pairs.

"Vin/Vmax, Vcc/Vmax"

Value pairs in "Envelope Voltage Adaptation > Manual/Auto Normalized" mode.

"Power(dBm), Vcc(V)"

Value pairs in "Envelope Voltage Adaptation > Auto Power" mode.

Remote command:

n.a.

**Goto, Edit, Save As, Save**

Standard functions for editing of data lists.

Changed and unsaved values are displayed on a yellow background.

Remote command:  
n.a.

#### Fill Table Automatically

Standard function for filling a table automatically with user-defined values.

"From / Range"

Defines the start line and number of the rows to be filled.

"Select Column to Fill"

Selects the respective value, including the unit.

"Start / End Value"

Default values corresponding to the selected column.

"Increment"

Determines the step size.

"Fill"

Fills the table.

Fill both columns and then save the list. Otherwise the entries are lost.

## 3.7 Polynomial Coefficients Setting

The polynomial function is an analytical method to describe a shaping function.

**To access the polynomial coefficients setting and define a higher-order polynomial**

1. Select "I/Q Analog > I/Q Analog Settings > General".

2. Enable "RF Envelope > On".
3. Select "Shaping Settings > Shaping > Polynomial".
4. Select "Envelope Voltage Adaptation > Auto Normalized".
5. Select "Polynomial Coefficients"

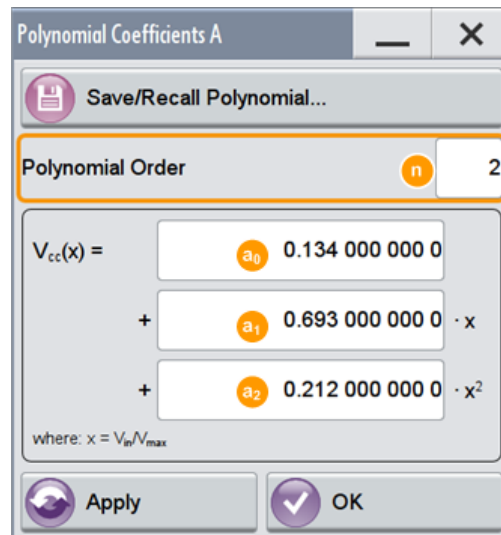

Figure 3-13: Polynomial Coefficients: Understanding the displayed information

With the provided settings, you can define a polynomial function with up to 10<sup>th</sup> order to describe the envelope shape.

6. Select "Polynomial Order = 2" (n = 2).
7. Set the constant  $a_0$  and the polynomial coefficients  $a_1$  and  $a_2$ .
8. Select "Apply".  
The instrument loads the configured values and displays the shaping function.
9. To store the defined shaping function:
  - a) Select "Save/Recall Polynomial"
  - b) Navigate throughout the file system and enter a "File Name", e.g. *MyPolynomial\_2thOrder*
  - c) Select "OK".
10. Select "Polynomial Coefficients > OK" to close the dialog.

Save/Recall Polynomial.....	45
Polynomial Order.....	45
Polynomial constant and coefficients.....	45
Apply, OK.....	45

**Save/Recall Polynomial**

Accesses the "Save/Recall" dialog, i.e. the standard instrument function for storing and recalling the complete dialog-related settings in a file. The provided navigation possibilities in the dialog are self-explanatory.

The file name and the directory it is stored in are user-definable; the file extension is however predefined.

The polynomial files are files with extension `*.iq_poly`, see ["File format of the polynomial function file"](#) on page 16.

Remote command:

`[ :SOURce<hw> ] :IQ:OUTPut [ :ANALog ] :ENVELOpe:SHAPing:COEFFicients:CATalog?` on page 97

`[ :SOURce<hw> ] :IQ:OUTPut [ :ANALog ] :ENVELOpe:SHAPing:COEFFicients:STORE` on page 97

`[ :SOURce<hw> ] :IQ:OUTPut [ :ANALog ] :ENVELOpe:SHAPing:COEFFicients:LOAD` on page 97

**Polynomial Order**

Defines the polynomial order  $n$ , that is the number of polynomial coefficients (see [Chapter 3.2.3.3, "About the Polynomial Function"](#), on page 15).

Select "Apply" to confirm the settings.

Remote command:

See `[ :SOURce<hw> ] :IQ:OUTPut [ :ANALog ] :ENVELOpe:SHAPing:COEFFicients` on page 97

**Polynomial constant and coefficients**

Sets the polynomial constant  $a_0$  and the polynomial coefficients  $a_1$  to  $a_n$ .

The polynomial constant and coefficients influence the envelope shape.

Remote command:

`[ :SOURce<hw> ] :IQ:OUTPut [ :ANALog ] :ENVELOpe:SHAPing:COEFFicients` on page 97

**Apply, OK**

Triggers the instrument to adopt the selected function.

Use "OK" to apply the setting and exits the dialog.

Remote command:

See `[ :SOURce<hw> ] :IQ:OUTPut [ :ANALog ] :ENVELOpe:SHAPing:COEFFicients` on page 97

## 4 Applying Digital Predistortion

Digital predistortion (DPD) is one of the methods, used to improve the efficiency of RF power amplifiers. In the R&S SMW, the generated digital signal can be deliberately AM/AM and AM/PM predistorted.

### 4.1 Required Options

The equipment layout for digital predistortion includes:

- Option Baseband Generator (R&S SMW-B10) per signal path
- Option Frequency (R&S SMW-B1xx/B2xx)
- Option Baseband main module, one/two I/Q paths to RF (R&S SMW-B13/B13T)
- Option AM/AM AM/PM Predistortion (R&S SMW-K541) per signal path
- Optional option Envelope Tracking (R&S SMW-K540) per signal path

### 4.2 About Digital Predistortion

Power amplifiers are an essential part of any telecommunication systems. While amplify the transmitted signal, power amplifiers may also distort this signal and change its amplitude and/or phase characteristics. Such distortions result in undesired effects like spectrum regrowth, harmonic generation, intermodulation (IM) products, or increased bit error rate.

#### The principle of the digital predistortion

To compensate for the distortions caused by the transmission system, the signal is deliberately digitally predistorted. Digital predistortion (DPD) is a method to apply wanted and well-defined predistortion on the signal to be transmitted so that when this signal is amplified, the resulting signal features the identical characteristics, as the initial signal before the predistortion.

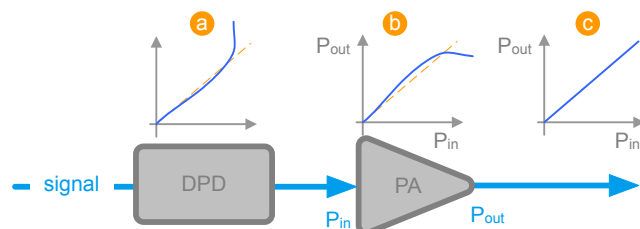

Figure 4-1: Illustration of predistortion principle

- DPD = digital predistortion  
PA = power amplifier  
a = predistortion function  
b = characteristic of the power amplifier, for example the non-linear input power vs. output power (AM/AM) function  
c = ideal linearized characteristic of the amplified signal

### Digital predistortion models

When testing power amplifiers, it is important to measure and analyze signal distortions.

There are several known models used to describe distortions. This implementation focuses on the following two types of distortion:

- The AM/AM (amplitude-to-amplitude) distortion and
- The AM/PM (amplitude-to-phase) distortion.

An AM/AM representation is a standard method that shows the signal power level at the input of the DUT against the power level at the output of the DUT. The default unit for both axes is dBm but the AM/AM representation can also be normalized.

An AM/PM curve shows the phase difference in degrees (y-axis) for every input power level (x-axis).

If your R&S SMW is equipped with the required option R&S SMW-K541, you can define both, an AM/AM and an AM/PM predistortion and apply them separately or superimposed on each other on the generated digital baseband signal.

If your instrument is equipped with the option R&S SMW-K540, you can also apply predistortions on the generated envelope signal.

Refer to [Chapter 3, "Generation of Envelope Tracking Signals"](#), on page 11 for more information.

## 4.2.1 Defining the Power Level of the Generated Signal

You can define the level of the generated signal in one of the following ways:

- **Level Reference > Before DPD**  
In this mode, the "Level" parameter in the status bar of the instrument defines the signal level before the DPD is applied.  
Signal with selected level is pre-distorted and depending on the selected AM/AM and AM/PM functions, attenuated or boosted.  
See [Table 4-1](#).
- **Level Reference > After DPD**  
In this mode, you define the resulting signal level. Based on this value and depending on current predistortion function, the R&S SMW calculates the level of the signal to be pre-distorted.  
The level calculation requires several interaction cycles; the number of iterations is a trade-off between level accuracy and speed.  
See ["To perform manual iterations to achieve a desired resulting signal level after the DPD"](#) on page 76 for explanation of how the interactions are performed.

Table 4-1: Difference between the level reference modes

"Level Reference > Before DPD"	"Level Reference > After DPD"
<p>1: "Level<sub>IN</sub> = Level = -15 dBm", i.e. signal level before DPD</p> <p>2: "PEP<sub>IN</sub> = PEP -3.43 dBm", i.e. PEP of the signal before DPD</p> <p>3: "Level<sub>OUT</sub> = -15.42 dBm", resulting signal level after DPD</p> <p>4: "PEP<sub>OUT</sub> = -3.68 dBm", resulting PEP of the signal after DPD</p>	<p>1: "Level<sub>OUT</sub> = Level = -15 dBm", i.e. signal level after DPD</p> <p>2: "PEP<sub>OUT</sub> = PEP = -3.57 dBm", i.e. PEP of the signal after DPD</p> <p>3: "Level<sub>IN</sub> = -15.43 dBm", calculated signal level before DPD</p> <p>4: "PEP<sub>IN</sub> = -3.86 dBm", calculated of the signal before DPD</p> <p>5: allowed maximum level error</p> <p>6: maximum number of iteration to be used to achieve the required level error</p>

### 4.2.2 Defining the Correction Values

In the R&S SMW, you can select the way you define the predistortion function and choose between:

- A polynomial function with up to 10 polynomial coefficients (see Chapter 4.2.2.1, "Polynomial Function", on page 48)
- A predistortion function defined as a look-up table (see Chapter 4.2.2.2, "Shaping Table", on page 49)
- A normalized data (see Chapter 4.2.2.3, "Normalized Data", on page 50)
- To set the correction values in raw format with a single remote control command (see Chapter 4.2.2.4, "Predistortion Function in Raw Data Format", on page 51).

#### 4.2.2.1 Polynomial Function

The polynomial function is an analytical method to describe a predistortion function. When using the polynomial function, you do not define the correction values ( $\Delta$ Power and  $\Delta$ Phase) directly as it is in the look-up table, but you describe the predistortion function and the R&S SMW derives the correction values out of it.

See Chapter 4.3.4, "Polynomial Coefficients Settings", on page 62.



This implementation uses a polynomial with complex coefficients defined as follows:

$$P_{\text{DPD}}(x) = \sum [(a_n + j \cdot b_n) \cdot x^n],$$

where:

- $n$  = "Polynomial Order"  $\leq 10$
- $x = P_{\text{in}}/P_{\text{inMax}}$
- $a_n$  and  $b_n$  are user-defined coefficients, defined as Cartesian (polar) or Cylindrical coordinates.  
In Cartesian coordinates system, the coefficients  $b_n$  are expressed in degrees.

The R&S SMW calculates the AM/AM and AM/PM predistortion functions as follows:

- $\text{AM/AM}(x) = \text{abs}[P_{\text{DPD}}(x)]$
- $\text{AM/PM}(x) = \tan^{-1}\{\text{Im}[P_{\text{DPD}}(x)]/\text{Re}[P_{\text{DPD}}(x)]\}$

A dedicated graphical display visualizes the resulting functions, see [Figure 4-4](#).

The R&S SMW calculates the correction values ( $\Delta\text{AM/AM}$  and  $\Delta\text{AM/PM}$  functions) as follows:

- $\Delta\text{AM/AM}(x) = \text{AM/AM}(x) - x = \text{abs}[P_{\text{DPD}}(x)] - x$
- $\Delta\text{AM/PM}(x) = \text{AM/PM}(x) = \tan^{-1}\{\text{Im}[P_{\text{DPD}}(x)]/\text{Re}[P_{\text{DPD}}(x)]\}$

A dedicated graphical display visualizes the calculated correction functions, see [Figure 4-5](#) and compare with [Figure 4-4](#).

#### File format of the polynomial file

You can store a polynomial function in a file or even define the polynomial coefficients, store them as a file and load this file into the instrument. The polynomial files are files with the extension \*.dpd\_poly.

The file contains an optional header # Rohde & Schwarz - Digital Predistortion Polynomial Coefficients # a0,b0, a1,b1, a2,b2, ... and a list of comma-separated coefficient value pairs, stored in Cartesian coordinates.

For values above the selected [Input Range \(PEP<sub>in</sub>\)](#), the predistortion function assumes a linear ratio of the input to output power.

#### Example: Polynomial function file content

```
# Rohde & Schwarz - Digital Predistortion Polynomial Coefficients
# a0,b0, a1,b1, a2,b2, ...
0,0,-0.25,0.2,0.6,-0.3,0.3,0.3,0.5,-0.4
```

#### 4.2.2.2 Shaping Table

In the R&S SMW, there are two ways to define the predistortion function in form of a shaping table:

- **Externally**

Create a correction table file as a CSV file with Microsoft Excel, with a Notepad or a similar tool, save it with the predefined extension, transfer it to and load it into the instrument.

See also ["File format of the correction table file"](#) on page 50.

- **Internally**

Use the built-in editor table editor, see [Chapter 4.3.3, "Edit Predistortion Table Settings"](#), on page 60.

### File format of the correction table file

The correction table files are files with predefined extension and simple file format, see [Table 4-2](#).

**Table 4-2: Shaping table files: format and extensions**

Predistortion model	File extension	Header (optional)
AM/AM	*.dpd_magn	# Rohde & Schwarz - Digital AM/AM Predistortion Table Pin[dBm],deltaPower[dB]
AM/PM	*.dpd_phase	# Rohde & Schwarz - Digital AM/PM Predistortion Table Pin[dBm],deltaPhase[deg]x

The header is optional. The file content is a list of up to 4000 comma-separated value pairs, describing the delta values for amplitude or phase related to the absolute input power  $P_{in}$ ; a new line indicator separates the pairs.

For values above the selected [Input Range \(PEP<sub>in</sub>\)](#), the predistortion function assumes a linear ratio of the input to output power.

#### Example: Shaping table file content (\*.dpd\_magn file)

```
# Rohde & Schwarz - Digital AM/AM Predistortion Table
Pin[dBm],deltaPower[dBm]
-30,0.5
3,-0.01
```

### 4.2.2.3 Normalized Data

In the R&S SMW, there are two ways to define the predistortion function as normalized data:

- **Externally**

We recommend that you calculate the normalized correction data by a connected R&S®FSW equipped with R&S®FSW-K18 Power Amplifier and Envelope Tracking Measurements option.

You can also create the correction table file as a CSV file with Microsoft Excel, with a Notepad or a similar tool, save it with the predefined extension, transfer it to and load it into the instrument.

See also ["File format of the correction table file"](#) on page 50.

- **Internally**

Use the built-in editor table editor, see [Chapter 4.3.3, "Edit Predistortion Table Settings"](#), on page 60.

#### File format of the normalized data

The normalized data files are files with predefined extension \*.dpd\_norm and simple file format, see ["File format of the normalized data"](#) on page 51.

The file contains an optional header # Rohde & Schwarz - Digital Predistortion Normalized Table Data # PinMax [dBm] # number of points # Vin/Vmax, deltaV/V, deltaPhase [deg], the values of the  $P_{in,max}$ , the number of the subsequent points and a list of comma-separated groups of three values.

#### Example: Normalized data file content

```
# Rohde & Schwarz - Digital Predistortion Normalized Table Data
# PinMax [dBm]
# number of points
# Vin/Vmax, deltaV/V, deltaPhase [deg]
10
4096
0,0,0
0.0002442,-0.00018246,0.28052
0.0004884,-0.00036487,0.28041
0.0007326,-0.00054723,0.2803
0.0009768,-0.00072954,0.28019
0.001221,-0.00091181,0.28008
0.0014652,-0.001094,0.27996
...
```

#### 4.2.2.4 Predistortion Function in Raw Data Format

The predistortion values are defined directly, with a single remote control command:

- Define the up to 4000 comma-separated value pairs, describing the absolute input power  $P_{in}$  and the delta values for amplitude or phase ( $\Delta$ Power and  $\Delta$ Phase).

##### Example:

```
SOURce1:IQ:DPD:SHAPing:TABLE:AMAM:FILE:DATA -30.4,-5.2,
-25.1,-4.5, -18.5,-2.5, -10.5,-1
```

See:

- [\[:SOURce<hw>\]:IQ:DPD:SHAPing:TABLE:AMAM:FILE:DATA](#) on page 108
- [\[:SOURce<hw>\]:IQ:DPD:SHAPing:TABLE:AMPM:FILE:DATA](#) on page 108
- [\[:SOURce<hw>\]:IQ:DPD:SHAPing:TABLE:AMAM:FILE:NEW](#) on page 107
- [\[:SOURce<hw>\]:IQ:DPD:SHAPing:TABLE:AMPM:FILE:NEW](#) on page 107
- Define the absolute maximum input power  $P_{in,max}$ , the number of subsequent points, and the normalized values  $V_{in}/V_{max}$ ,  $\Delta V/V$ ,  $\Delta$ Phase [deg] as binary data.

See [ :SOURCE<hw> ] :IQ:DPD:SHAPing:NORMalized:DATA on page 109.

### 4.2.3 Finding Out the Correction Values

If you know the properties of the used power amplifier, you can calculate suitable correction values.

To explain the principle, we assume that the characteristics of a power amplifier have been measured and that the left graphic in the following table shows the AM/AM curve of this amplifier.

Defining correction coefficients for an AM/AM predistortion (Example)

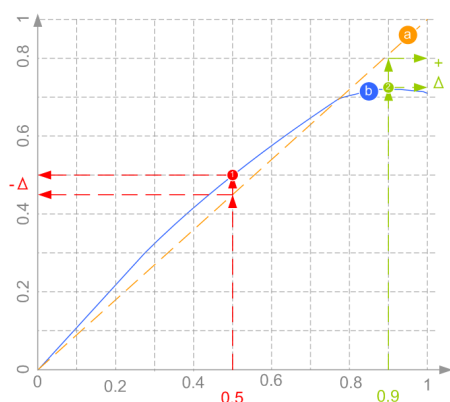

- a = ideal characteristic; if the amplifier did not distort the signal, the normalized magnitude would a line
- b = measured AM/AM curve; the normalized magnitude varies as a function of input power

Resulting AM/AM predistortion function (Example)

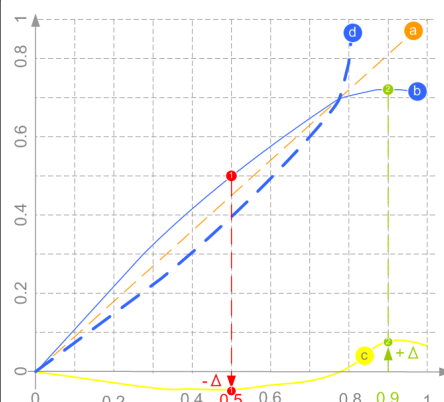

- a = ideal characteristic
- b = measured AM/AM curve
- c = resulting AM/AM predistortion function, i.e. correction values curve
- d = ideal predistorted signal

The required correction coefficient  $\Delta$ Power is the difference between the ideal and the real normalized amplitude for one particular input power. To compensate for the non-linearity and the deviation from the ideal line, select a negative correction value ( $-\Delta$ ) for any input power where the real normalized amplitude is greater than the ideal one (1). Logically, a positive correction value ( $+\Delta$ ) compensates for (i.e. boost) an amplitude that is smaller than the ideal one (2).

Ideally, a signal predistorted with a suitable function (c) and then amplified by the particular PA would have a linear characteristic (a).

In the practice, however, you do not calculate the correction coefficients manually but they are calculated automatically. A suitable solution is the R&S®FS-K130PC software or the R&S®FSW-K18 Power Amplifier and Envelope Tracking Measurements option, see [Chapter 6, "How to Apply a Digital Predistortion to Improve the Efficiency of RF Power Amplifiers"](#), on page 74.

### 4.3 Digital Predistortions AM/AM and AM/PM Settings

You can add digital predistortion to the generated baseband signal and thus compensate an amplitude as well as a phase distortion of the DUT, for example of the tested power amplifier (PA).

#### To access the required settings

- ▶ Select "I/Q Mod > Digital Predistortion > AM/AM AM/PM".

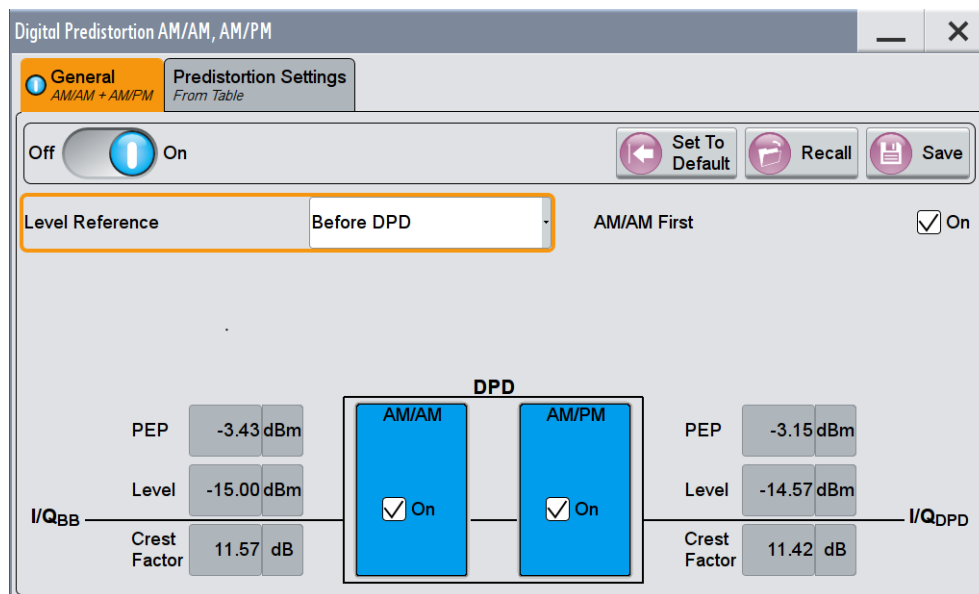

The dialog covers the settings for digital predistortion, like select and enabling an AM/AM and/or AM/PM predistortion, select the way the predistortion function are defined and specify the correction values.

The remote commands required to define these settings are described in [Chapter 7.3, "SOURCE:IQ:DPD Subsystem"](#), on page 99.

#### 4.3.1 General Settings

State.....	54
Set to Default.....	54
Save/Recall.....	54
AM/AM First.....	54
Level Reference.....	54
Maximum Output Level Error.....	55
Maximum Number of Iterations.....	55
Achieved Output Level Error.....	55
Input/Output PEP, Level and Crest Factor.....	55
AM/AM and AM/PM State.....	55

**State**

Enables/disables the generation of digital predistorted signals.

Remote command:

`[ :SOURce<hw> ] :IQ:DPD:STATe` on page 102

**Set to Default**

Calls the default settings. The values of the main parameters are listed in the following table.

Parameter	Value
"State"	Not affected by the "Set to Default"
"Level Reference"	Before DPD
"AM/PM, AM/AM"	Off

Remote command:

`[ :SOURce<hw> ] :IQ:DPD:PRESet` on page 102

**Save/Recall**

Accesses the "Save/Recall" dialog, that is the standard instrument function for storing and recalling the complete dialog-related settings in a file. The provided navigation possibilities in the dialog are self-explanatory.

The file name and the directory, in which the settings are stored, are user-definable; the file extension is however predefined.

See also, chapter "File and Data Management" in the R&S SMW user manual.

Remote command:

`[ :SOURce<hw> ] :IQ:DPD:SETTing:CATalog?` on page 102

`[ :SOURce<hw> ] :IQ:DPD:SETTing:STORe` on page 103

`[ :SOURce<hw> ] :IQ:DPD:SETTing:LOAD` on page 103

`[ :SOURce<hw> ] :IQ:DPD:SETTing:DELeTe` on page 103

**AM/AM First**

Toggles the order the AM/AM and AM/PM predistortions are applied.

Remote command:

`[ :SOURce<hw> ] :IQ:DPD:AMFirst` on page 103

**Level Reference**

Switches between dynamic and static adaptation of the range the selected DPD is applied on.

"Before DPD/After DPD"

Selects dynamic range calculation and defines whether the selected "Level" value corresponds to the signal level before or after the predistortion, see [Chapter 4.2.1, "Defining the Power Level of the Generated Signal"](#), on page 47.

"Static DPD"

Selects static (constant) range limits. To adjust the range, use the parameter [Pre-Gain](#).

Remote command:

[ :SOURce<hw> ] : IQ:DPD:LREFErence on page 104

#### Maximum Output Level Error

Sets the allowed maximum error, see [Chapter 4.2.1, "Defining the Power Level of the Generated Signal"](#), on page 47.

Remote command:

[ :SOURce<hw> ] : IQ:DPD:OUTPut:ERRor:MAX on page 104

#### Maximum Number of Iterations

Sets the maximum number of performed iterations to achieving the required [Maximum Output Level Error](#).

See also [Chapter 4.2.1, "Defining the Power Level of the Generated Signal"](#), on page 47.

Remote command:

[ :SOURce<hw> ] : IQ:DPD:OUTPut:ERRor:MAX on page 104

#### Achieved Output Level Error

Displays the resulting level error, see [Chapter 4.2.1, "Defining the Power Level of the Generated Signal"](#), on page 47.

Remote command:

[ :SOURce<hw> ] : IQ:DPD:OUTPut:ERRor? on page 104

#### Input/Output PEP, Level and Crest Factor

Displays the calculated values the before and after the DPD

See ["To perform manual iterations to achieve a desired resulting signal level after the DPD"](#) on page 76.

A value of -1000 indicates that the calculation is impossible or there are no measurements results available.

Remote command:

[ :SOURce<hw> ] : IQ:DPD:INPut:PEP? on page 105

[ :SOURce<hw> ] : IQ:DPD:INPut:LEVel? on page 105

[ :SOURce<hw> ] : IQ:DPD:INPut:CFACTOR? on page 105

[ :SOURce<hw> ] : IQ:DPD:OUTPut:PEP? on page 105

[ :SOURce<hw> ] : IQ:DPD:OUTPut:LEVel? on page 105

[ :SOURce<hw> ] : IQ:DPD:OUTPut:CFACTOR? on page 105

#### AM/AM and AM/PM State

Enables/disables the AM/AM and AM/PM digital predistortion.

If both predistortions are enabled simultaneously, the instrument applies the AM/AM predistortion first and compensates the phase error of the PA afterwards.

Compare the displayed signal processing chain.

Remote command:

[ :SOURce<hw> ] : IQ:DPD:AMAM:STATe on page 103

[ :SOURce<hw> ] : IQ:DPD:AMPM:STATe on page 103

### 4.3.2 Predistortion Settings

#### To access the "Predistortion Settings"

1. Select "I/Q Mod > Digital Predistortion > AM/AM AM/PM".
2. Select "Digital Predistortion AM/AM, AM/PM > Predistortion Settings".

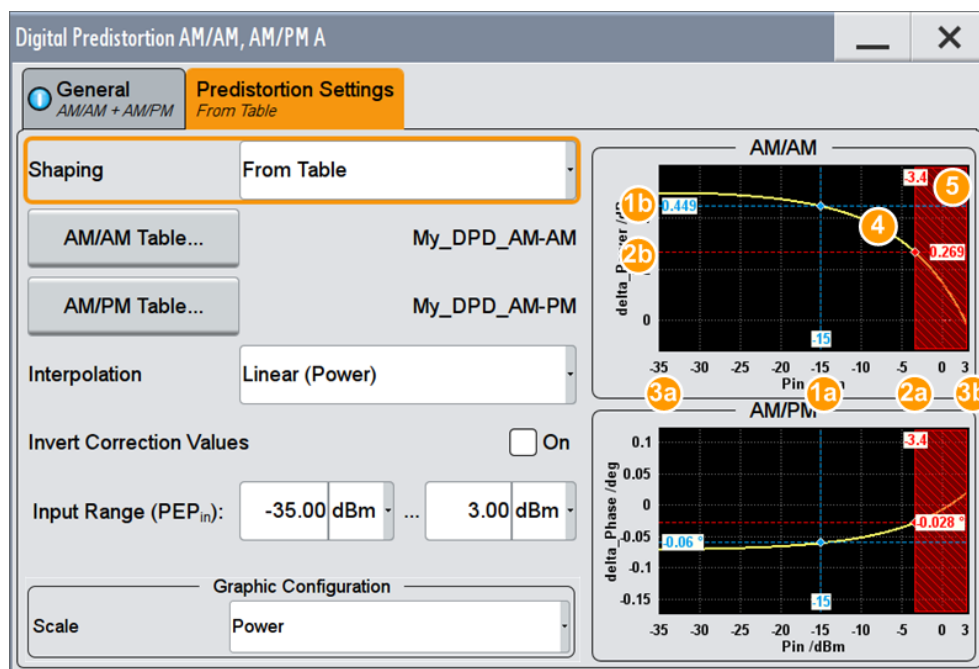

Figure 4-2: Predistortion Settings > From Table: Understanding the displayed information

- 1a = Normalized value of the current RF RMS power level
- 2a = Normalized value of the current PEP of the generated RF signal
- 1b, 2b = Correction values
- white dashed line = Ideal zero correction function; no correction is necessary
- yellow curve = Predistortion function
- 3a, 3b = Input Range (PEP<sub>in</sub>)
- 4 = Positive correction coefficients to compensate values below the ideal ones
- 5 = Values greater than the PEP<sub>in</sub> Max are ignored

The dialog covers the settings for digital predistortion, like select and enabling an AM/AM and/or AM/PM predistortion, select the way the predistortion function is defined and specify the correction values.

- Shaping..... 57
- Interpolation..... 57
- Invert correction values..... 57
- Input Range (PEP<sub>in</sub>)..... 58
- Pre-Gain..... 58
- Shaping Table..... 59
- Polynomial Coefficients..... 59
- Normalized Data..... 59



Graphic Configuration..... 59  
 L Scale..... 59  
 L AM/AM and AM/PM Diagrams..... 59

**Shaping**

Selects the method to define the correction coefficients.

- "From Table" As value pairs in form of a shaping table.  
 Select "AM/AM or AM/PM Shaping Table" to access the settings, see Chapter 4.3.3, "Edit Predistortion Table Settings", on page 60
- "Polynomial" By a polynomial with configurable order and coefficients.  
 Select "AM/AM or AM/PM Polynomial Coefficients" to access the settings, see Chapter 4.3.4, "Polynomial Coefficients Settings", on page 62.
- "Normalized" As a normalized data.  
 Select "Normalized Data" to access the settings, see Chapter 4.3.5, "Normalized Data Settings", on page 66.

Remote command:

```
[ :SOURce<hw> ] :IQ:DPD:SHAPing:MODE on page 106
```

**Interpolation**

Enabled in "Shaping > From Table/Normalized".

A predistortion function defined in a table contains a limited number of value pairs. This parameter enables a linear interpolation between the defined values to prevent abrupt changes.

Table 4-3: Effect of parameter "Interpolation"

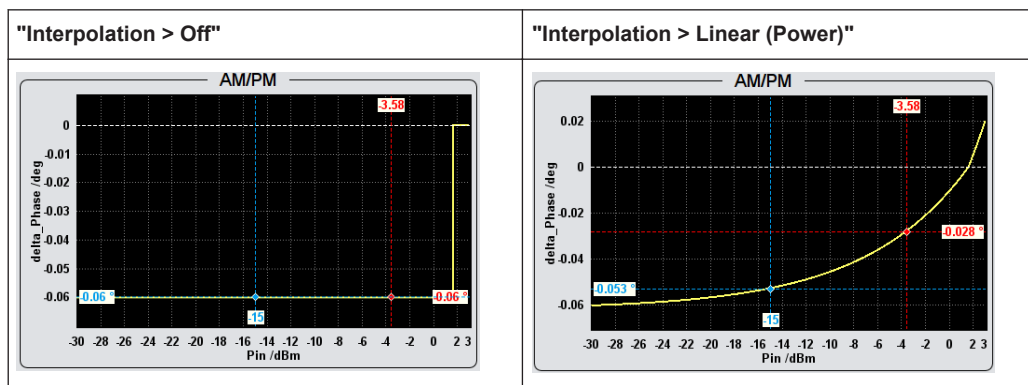

Remote command:

```
[ :SOURce<hw> ] :IQ:DPD:SHAPing:TABLE:INTerp on page 108
```

**Invert correction values**

Inverts the defined correction values.

Use this function to apply the exact invert predistortion coefficients without to change the defined predistortion table.

This function is also useful to toggle between predistortions with corrections related to the input power and to the output power.

Table 4-4: Effect of parameter "Invert correction values"

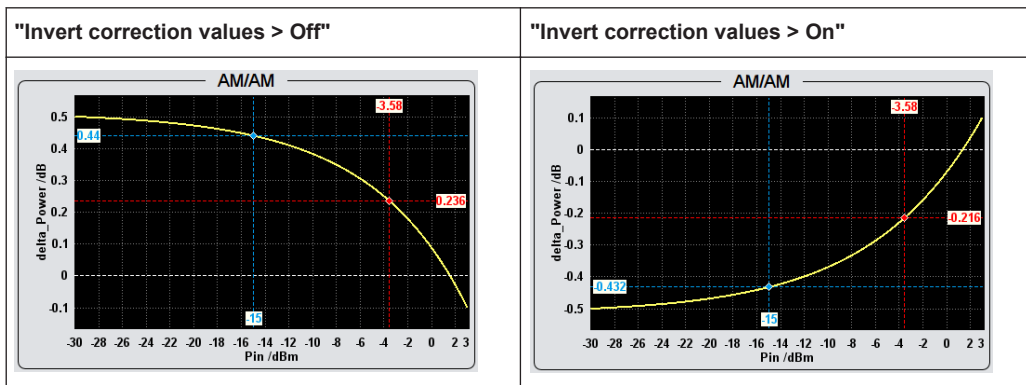

Remote command:

```
[ :SOURce<hw> ] :IQ:DPD:SHAPing[:TABLE]:INVert on page 108
```

**Input Range (PEP<sub>in</sub>)**

Defines the minimum and maximum input power PEP<sub>in</sub>.

If you apply digital predistortion on signals used for power amplifier tests with envelope tracking, set the PEP<sub>in</sub>Max value to the maximum value of the input power PEPin Max, as required by the used power amplifier (PA).

Remote command:

```
[ :SOURce<hw> ] :IQ:DPD:PIN:MIN on page 105
```

```
[ :SOURce<hw> ] :IQ:DPD:PIN:MAX on page 105
```

**Pre-Gain**

In "Level Reference > Static DPD" mode, sets a pre-gain (i.e. an attenuation) to define the range the DPD is applied in. The pre-gain can be used to define and test only a specific (required) part of the operating range.

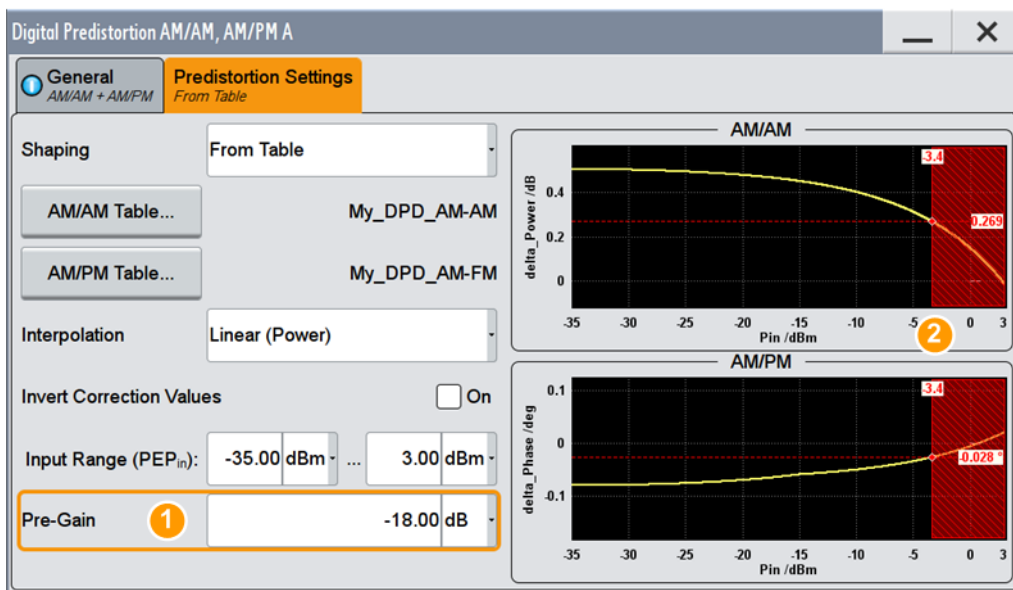

- 1 = Pre-gain limits the effective range of the shaping function
- 2 = Values above this limit are ignored

In "Level Reference > Before/After DPD" mode, the range is limited by the current PEP of the signal, see [Figure 4-2](#).

Remote command:

`[ :SOURce<hw> ] :IQ:DPD:GAIN:PRE` on page 106

### Shaping Table

Accesses the standard "Predistortion Select" dialog with functions to define a new shaping table file, select, or edit an existing one.

The shaping table files are files with predefined extension and file format, see "[File format of the correction table file](#)" on page 50.

You can create a shaping table externally or internally.

"Select"               Selects and loads an existing file

"New"                 Creates a file

"Edit"                Access a standard built-in table editor, see [Chapter 4.3.3, "Edit Predistortion Table Settings"](#), on page 60.

Remote command:

For AM/AM distortions:

`[ :SOURce<hw> ] :IQ:DPD:SHAPing:TABLE:AMAM:FILE:CATalog?` on page 107

`[ :SOURce<hw> ] :IQ:DPD:SHAPing:TABLE:AMAM:FILE[:SElect]` on page 107

For AM/PM distortions:

`[ :SOURce<hw> ] :IQ:DPD:SHAPing:TABLE:AMPM:FILE:CATalog?` on page 107

`[ :SOURce<hw> ] :IQ:DPD:SHAPing:TABLE:AMPM:FILE[:SElect]` on page 107

### Polynomial Coefficients

Accesses a dialog to describe the predistortion function as a polynomial function, see [Chapter 4.3.4, "Polynomial Coefficients Settings"](#), on page 62.

### Normalized Data

Accesses a dialog to describe the predistortion function as a normalized data, see [Chapter 4.3.5, "Normalized Data Settings"](#), on page 66.

### Graphic Configuration

Comprises setting to configure the graphical display.

#### Scale ← Graphic Configuration

Determines the units, "Voltage" or "Power", used on the x-axis.

Remote command:

`[ :SOURce<hw> ] :IQ:DPD:SCALE` on page 106

#### AM/AM and AM/PM Diagrams ← Graphic Configuration

Visualize the resulting AM/AM and/or AM/PM predistortion functions, as function of the selected  $PEP_{in}$  value limits.

See [Figure 4-2](#).

Remote command:

`[ :SOURce<hw> ] :IQ:DPD:AMAM:VALue:LEVel?` on page 111

`[ :SOURce<hw> ] :IQ:DPD:AMAM:VALue:PEP?` on page 111

[ :SOURce<hw> ] : IQ : DPD : AMAM : VALue? on page 112

[ :SOURce<hw> ] : IQ : DPD : AMPM : VALue : LEVel? on page 111

[ :SOURce<hw> ] : IQ : DPD : AMPM : VALue : PEP? on page 111

[ :SOURce<hw> ] : IQ : DPD : AMPM : VALue? on page 112

### 4.3.3 Edit Predistortion Table Settings

The predistortion table is an internal editor where you define the correction values,  $\Delta$ Power and  $\Delta$ Phase, in form of a look-up table.

#### To access the internal table editor

1. Select "I/Q Mod > Digital Predistortion > AM/AM AM/PM".
2. Select "Digital Predistortion AM/AM AM/PM > Predistortion Settings".
3. Select "Shaping > From Table".
4. Select "AM/AM > Shaping Table > Predistortion AM/AM Shaping File > New"
5. Enter the "File Name", e.g. *My\_DPD\_AM-AM*  
The "Predistortion AM/AM Shaping File" dialog closes.  
The "Shaping Table > My\_DPD\_AM-AM" confirms that the newly created file is assigned.
6. Select "Shaping Table > Predistortion AM/AM Shaping File > Edit"
7. Define the value pairs "Pin/dBm" and " $\Delta$ Power/dB". The order is uncritical.

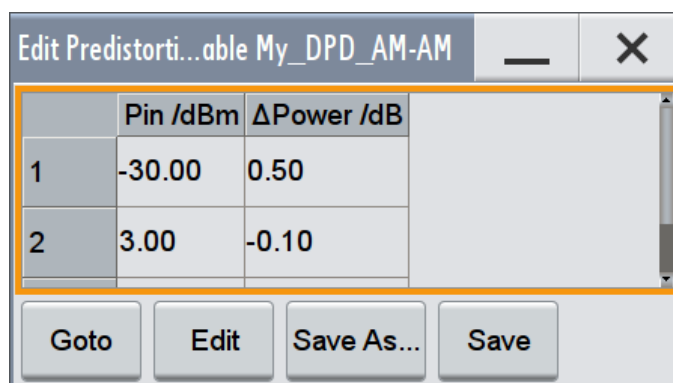

	Pin /dBm	$\Delta$ Power /dB
1	-30.00	0.50
2	3.00	-0.10

Figure 4-3: Example of an AM-AM predistortion table values

8. Select "Save".  
The instrument loads the configured values automatically and displays the function of the delta correction values.
9. Select "Predistortion Settings > Interpolation > Linear".  
The display confirms the used interpolation.

Pin (dBm), Delta Power (dB) / Pin (dBm), Delta Phase (deg).....61  
 Goto, Edit, Save As, Save.....61  
 Fill Table Automatically..... 61

**Pin (dBm), Delta Power (dB) / Pin (dBm), Delta Phase (deg)**

Sets the correction value pairs.

"Pin, ΔPower"

Value pairs for the AM/AM predistortion

"Pin, ΔPhase"

Value pairs for the AM/PM predistortion

Remote command:

See [:SOURCE<hw>]:IQ:DPD:SHAPing:TABLE:AMAM:FILE[:SElect]  
 on page 107

and [:SOURCE<hw>]:IQ:DPD:SHAPing:TABLE:AMPM:FILE[:SElect]  
 on page 107

**Goto, Edit, Save As, Save**

Standard functions for editing of data lists.

Changed and unsaved values are displayed on a yellow background.

Remote command:

n.a.

**Fill Table Automatically**

Standard function for filling a table automatically with user-defined values.

"From / Range"	Defines the start line and number of the rows to be filled.
"Select Column to Fill"	Selects the respective value, including the unit.
"Start / End Value"	Default values corresponding to the selected column.
"Increment"	Determines the step size.
"Fill"	Fills the table. Fill both columns and then save the list. Otherwise the entries are lost.

#### 4.3.4 Polynomial Coefficients Settings

Alternatively to the look-up table, you can define the predistortion functions as a polynomial function. The R&S SMW calculates the AM/AM and AM/PM predistortion functions and the required correction coefficients out of the defined polynomial.

**To access the polynomial coefficients setting and define a higher-order polynomial**

1. Select "I/Q Mod > Digital Predistortion > AM/AM AM/PM".
2. Select "Digital Predistortion AM/AM AM/PM > Predistortion Settings".
3. Select "Shaping > Polynomial".
4. Select "AM/PM > Polynomial Coefficients"

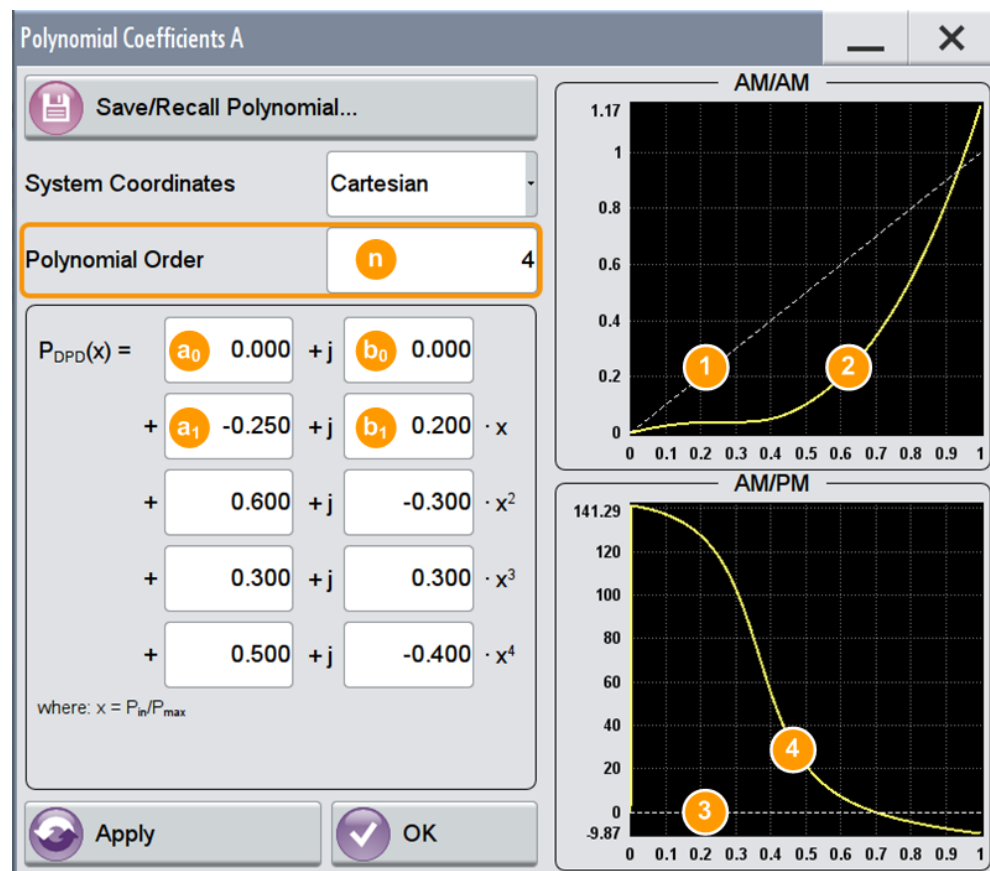

Figure 4-4: Polynomial Coefficients: Understanding the displayed information

- n = Polynomial order
- a<sub>0</sub>, b<sub>0</sub>, ... = Polynomial coefficients
- 1 = Ideal AM/AM function (the normalized amplitude is a line)
- 2 = Resulting AM/AM predistortion function, calculated as  $AM/AM(x) = \text{abs}[P_{DPD}(x)]$
- 3 = Ideal AM/PM function (constant phase at 0 degrees)
- 4 = Resulting AM/PM predistortion function, calculated as  $AM/PM(x) = \tan^{-1}\{\text{Im}[P_{DPD}(x)]/\text{Re}[P_{DPD}(x)]\}$

With the provided settings, you can define a polynomial function with up to 10<sup>th</sup> order to describe the predistortion function.

The graphical display updates on-the-fly and visualizes the resulting AM/AM and AM/PM functions.

5. Select "Polynomial Order = 4" (n = 4).
6. Set the polynomial coefficients a<sub>0</sub> to b<sub>4</sub>.
7. Select "Apply".

The instrument loads the configured values, calculates the correction values, and displays the predistortion functions.

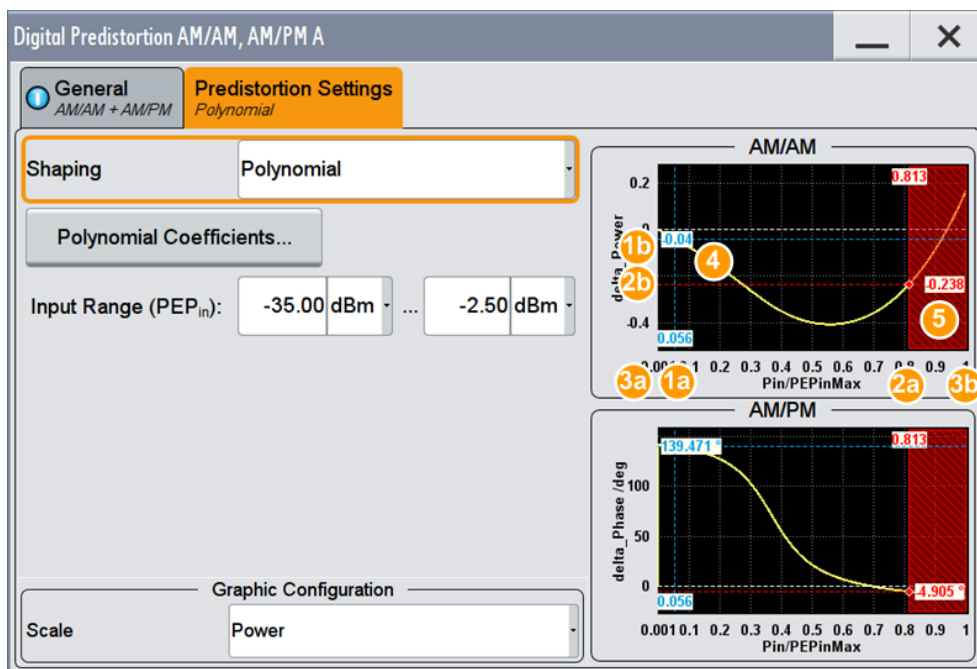

Figure 4-5: Predistortion Settings > Polynomial: Understanding the displayed information

- 1a = Normalized value of the current RF RMS power level
- 2a = Normalized value of the current PEP of the generated RF signal
- 1b, 2b = Correction values
- white dashed line = Ideal zero function; no correction is necessary
- AM/AM yellow curve = AM/AM correction values, calculated as  $\Delta AM/AM(x) = AM/AM(x) - x$
- AM/PM yellow curve = AM/PM correction values, calculated as  $\Delta AM/PM(x) = AM/PM(x)$
- 3a, 3b = X-axis scale, calculated from the **Input Range (PEP<sub>in</sub>)**
- 4 = Negative correction coefficients
- 5 = Values greater than the **PEP<sub>in</sub> Max** are ignored

8. To store the defined predistortion function:
  - a) Select "Save/Recall Polynomial"
  - b) Navigate throughout the file system and enter a "File Name", e.g. *MyPolynomial\_4thOrder*
  - c) Select "OK".
9. Select "Polynomial Coefficients > OK" to close the dialog.

Save/Recall Polynomial.....	64
System Coordinates.....	65
Polynomial Order.....	65
Polynomial coefficients.....	65
Apply, OK.....	65

**Save/Recall Polynomial**

Accesses the "Save/Recall" dialog, i.e. the standard instrument function for storing and recalling the dialog-related settings in a file. The provided navigation possibilities in the dialog are self-explanatory.



The file name and the directory it is stored in are user-definable; the file extension is however predefined.

The polynomial files are files with extension `*.dpd_poly`, see ["File format of the polynomial file"](#) on page 49. The polynomial function is stored in Cartesian format.

Remote command:

`[ :SOURce<hw> ] :IQ:DPD:SHAPing:POLYnomial:COEFFicients:CATalog?`  
on page 109

`[ :SOURce<hw> ] :IQ:DPD:SHAPing:POLYnomial:COEFFicients:LOAD`  
on page 109

`[ :SOURce<hw> ] :IQ:DPD:SHAPing:POLYnomial:COEFFicients:STORE`  
on page 109

### System Coordinates

Defines whether the polynomial function is defined in Cylindrical (Polar) or in Cartesian coordinates.

Remote command:

n.a.

### Polynomial Order

Defines the polynomial order  $n$ , that is the number of polynomial coefficients (see [Chapter 4.2.2.1, "Polynomial Function"](#), on page 48).

The polynomial order defines the degree, complexity, and the number of terms in the polynomial function.

Remote command:

See `[ :SOURce<hw> ] :IQ:DPD:SHAPing:POLYnomial:COEFFicients`  
on page 108

### Polynomial coefficients

Sets the polynomial coefficients  $a_0$  to  $a_n$  and  $b_0$  to  $b_n$ .

In "System Coordinates > Cylindrical", the polynomial coefficients  $b_0$  to  $b_n$  are expressed in degrees.

The polynomial coefficients influence the shape of the predistortion function, see [Figure 4-4](#) for an illustration of a polynomial function.

Select "Apply" to confirm the settings.

Remote command:

See `[ :SOURce<hw> ] :IQ:DPD:SHAPing:POLYnomial:COEFFicients`  
on page 108

### Apply, OK

Triggers the instrument to adopt the selected function.

Use "OK" to apply the setting and exits the dialog.

Remote command:  
n.a.

### 4.3.5 Normalized Data Settings

The normalized data table is an internal editor where you define the correction values,  $V_{in}/V_{max}$ ,  $\Delta V/V$  and  $\Delta Phase$ , in form of a table.

#### To access the internal editor

1. Select "I/Q Mod > Digital Predistortion > AM/AM AM/PM".
2. Select "Digital Predistortion AM/AM AM/PM > Predistortion Settings".
3. Select "Shaping > Normalized Data".
4. Select "Normalized Data".

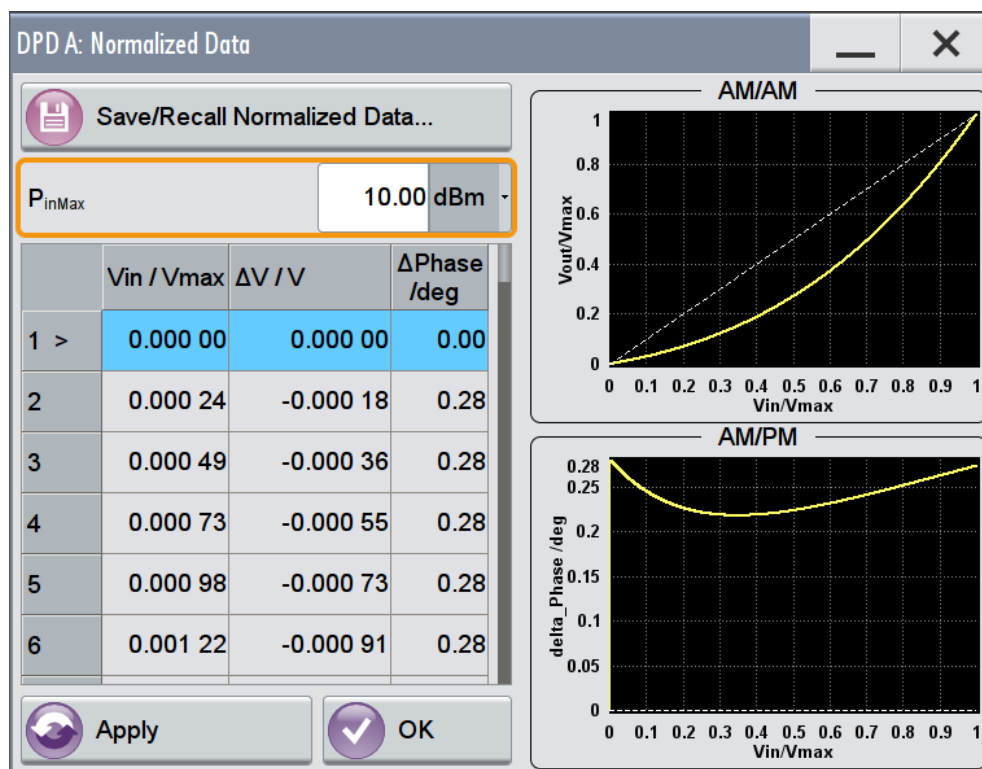

5. Enter the  $P_{in_{max}}$ .  
**Note:** Enter the correction values in the required order. The value range of the subsequent correction values is automatically adjusted.
6. To store the setting in a file, select "Save/Recall Normalized Data > Save". Enter a "File Name", e.g. *My\_DPD\_Normalized*.

Save/Recall Normalized Data.....	67
$P_{in_{max}}$ .....	67
$V_{in}/V_{max}$ , $\Delta V/V$ , $\Delta Phase$ (deg).....	67
Apply, OK.....	67

#### Save/Recall Normalized Data

Accesses the "Save/Recall" dialog, i.e. the standard instrument function for storing and recalling the dialog-related settings in a file. The provided navigation possibilities in the dialog are self-explanatory.

The file name and the directory it is stored in are user-definable; the file extension is however predefined.

The normalized data files are files with extension \*.dpd\_norm, see "File format of the normalized data" on page 51.

Remote command:

[ :SOURce<hw> ] :IQ:DPD:SHAPing:NORMALized:DATA:CATalog? on page 110

[ :SOURce<hw> ] :IQ:DPD:SHAPing:NORMALized:DATA:LOAD on page 110

[ :SOURce<hw> ] :IQ:DPD:SHAPing:NORMALized:DATA:STORE on page 111

#### $P_{in_{max}}$

Sets the value of the maximum input power level.

$P_{in_{max}}$  corresponds to a normalized input power of 1, that is the max. allowed value on the x-axis.

Select "Apply" to confirm the settings.

Remote command:

See [ :SOURce<hw> ] :IQ:DPD:SHAPing:NORMALized:DATA on page 109

#### $V_{in}/V_{max}$ , $\Delta V/V$ , $\Delta Phase$ (deg)

Sets the correction as a group of three values.

Select "Apply" to confirm the settings.

Remote command:

See [ :SOURce<hw> ] :IQ:DPD:SHAPing:NORMALized:DATA on page 109

#### Apply, OK

Triggers the instrument to adopt the normalized data.

Use "OK" to apply the setting and exits the dialog.

Remote command:

n.a.

## 4.4 Compensating Non-linear RF Effects

The R&S SMW provides a built-in function for compensating of its own non-linear RF effects caused by the amplifiers. If the function is enabled, the instrument uses the digital predistortion function and applies automatically calculated AM/AM predistortion values to the generated baseband signal.

The RF linearization and the "Digital Predistortions, AM/AM and AM/PM" cannot be used simultaneously; activating the "Linearize RF" parameter disables the "Digital Predistortions, AM/AM and AM/PM" settings.

To access the required settings:

1. Select "I/Q Mod > I/Q Modulator > General > Linearize RF".
2. Select "Adjust Linearization Current Frequency".

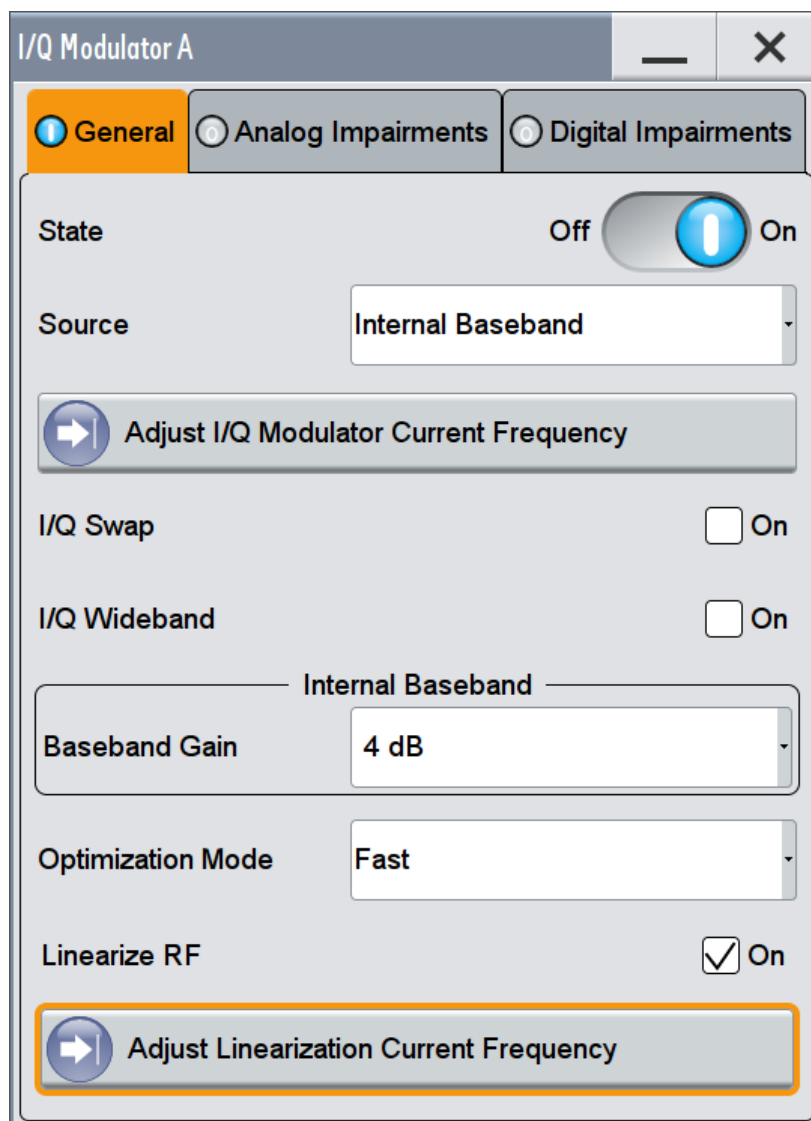

The R&S SMW calculates the required correction values for the selected RF and the current generated signal.

#### Linearize RF

In instruments equipped with option R&S SMW-K541, enables an automatic AM/AM predistortion of the non-linear RF chain.

During RF linearization, the "Digital Predistortions AM/AM and AM/PM" settings are disabled.

Remote command:

`[ :SOURce<hw> ] :IQ:DPD:LRF:STATe` on page 112

#### **Adjust Linearization Current Frequency**

The correction data is calculated for the currently selected frequency.

During RF linearization, the "Digital Predistortions AM/AM and AM/PM" settings are disabled.

Remote command:

`[ :SOURce<hw> ] :IQ:DPD:LRF:ADJust?` on page 113

## 5 How to Generate a Control Signal for Power Amplifier Envelope Tracking Tests

Refer to [Figure 3-1](#) for an example of a simplified test setup for power amplifier testing with envelope tracking. The illustration is intended to explain the principle in general, not all connections and required equipment are considered.

The R&S SMW in this setup is configured to generate an LTE RF signal with complex modulation scheme and high peak to average power (PAPR), and the required envelope signal. A polynomial shaping function is defined.

The PA receives the RF input signal and the dynamically adapted supply voltage. Ideally, the gain of the PA should stay constant.

Required are the following values:

- Characteristics of the power amplifier: supply voltage  $V_{CC}$ , the input power  $PEP_{in}$
- Characteristics of the external DC modulator: gain, peak-to-peak voltage  $V_{PP}$ , input impedance  $R_{in}$

### To configure the R&S SMW to generate the RF and RF envelope signal

1. Enable the R&S SMW to generate an EUTRA/LTE FDD DL signal.  
Select "Baseband > EUTRA/LTE" and enable for example:
  - a) Select "Link Direction > Downlink"
  - b) Select "Test Model > E-TM1\_1--5MHZ"
  - c) Enable "State > On"
2. Set "Frequency = 2.143 GHz" and "Level = -15 dB"
3. In the block diagram, select "I/Q Out > I/Q Analog > I/Q Analog Outputs > General" and perform the following:
  - a) Select "RF Envelope > On".
  - b) Select "Envelope Voltage Adaptation > Auto Power"
  - c) Select "I/Q Output Type > Differential"
  - d) Configure the settings as shown on [Figure 3-3](#).
  - e) Select "I/Q Analog Outputs > Envelope Settings" and set for example "Envelope to RF Delay = 10 ps"
  - f) Select "I/Q Analog Outputs > Shaping > Shape > Detrouching".
  - g) Set "Detrouching Function = 1:  $f(x) = x + d \cdot e^{(-x/d)}$ ".
  - h) Set "Detrouching Factor (d) > Coupled with Vcc = On".
  - i) Select "Graphic Configuration > Scale > Power".

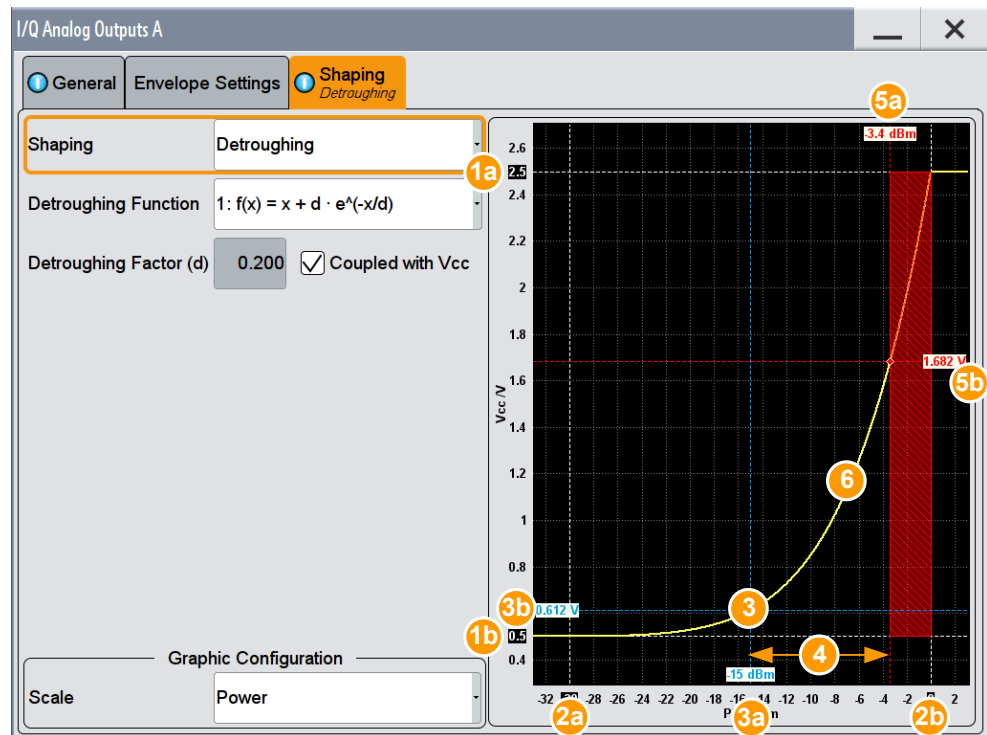

- 1a, 1b =  $V_{CCmin} = 0.5 \text{ V}$ ,  $V_{CCmax} = 2.5 \text{ V}$
- 2a, 2b =  $P_{inmin} = -30 \text{ dBm}$ ,  $P_{inmax} = 0 \text{ dBm}$
- 3 = RF Level =  $-15 \text{ dBm}$  (operating point)
- 3a = current  $V_{CC} = 0.612 \text{ V}$  (operating point)
- 4 = PEP =  $-3.4 \text{ dBm}$ ; current  $P_{inmax}$  limit
- 4a = current  $V_{CC}$  limit =  $1.682 \text{ V}$
- 5 = crest factor =  $11.6 \text{ dB}$
- 6 = operating point
- 7 = current envelope shape

4. Select "I/Q Analog Output > State > On"
5. Enable "RF > State > On".
6. Trigger the signal generation
7. Select "I/Q Out > I/Q Analog > I/Q Analog Outputs > General", enable "Power Offset = 1 dB" and compare the operating point.

The level display value in the status bar of the instrument shows "Level =  $-14 \text{ dBm}$ " and confirms that a "Level Offset = Power Offset =  $1 \text{ dB}$ " is enabled.

The instrument generates and outputs:

- An RF signal with the specified level and level offset
- An RF envelope signal that follows the power changes of the RF signal.

The envelope signal E is output at the I OUT connector; the inverted envelope signal E BAR at the I BAR OUT. The voltage of this envelope signal is automatically adjusted so that the supply voltage stays within the specified limits.

To observe the impact of baseband signal and its crest factor on the generated envelope signal, try out the following:

- Select "Baseband > Off" and compare the displayed envelope shape, in particular the shaded area.
- Select "Baseband > On", enable "Baseband > EUTRA/LTE > Filter/Clipping/ARB... > Clipping > State > On" and select "Clipping Level = 75%"

### Possible extensions

Consider to extend the test setup as follows:

- To apply digital predistortion (DPD) on the baseband signal and compare the behavior of the power amplifier (DUT)  
See [Chapter 6, "How to Apply a Digital Predistortion to Improve the Efficiency of RF Power Amplifiers"](#), on page 74.
- To perform RF analysis, use the R&S®FSW
- To measure and evaluate the AM/AM and AM/PM distortions, use the R&S®FSW-K18 Power Amplifier and Envelope Tracking Measurements.
- To observe the characteristics of the generated signal, use an oscilloscope, for example R&S®RTO

### How to optimize the signal to improve the linearity and efficiency of the power amplifier

Refer to [Figure 5-1](#) for an example of a simplified test setup for power amplifier testing with envelope tracking and digital predistortion. The illustration is intended to explain the principle in general, not all connections and required equipment are considered.

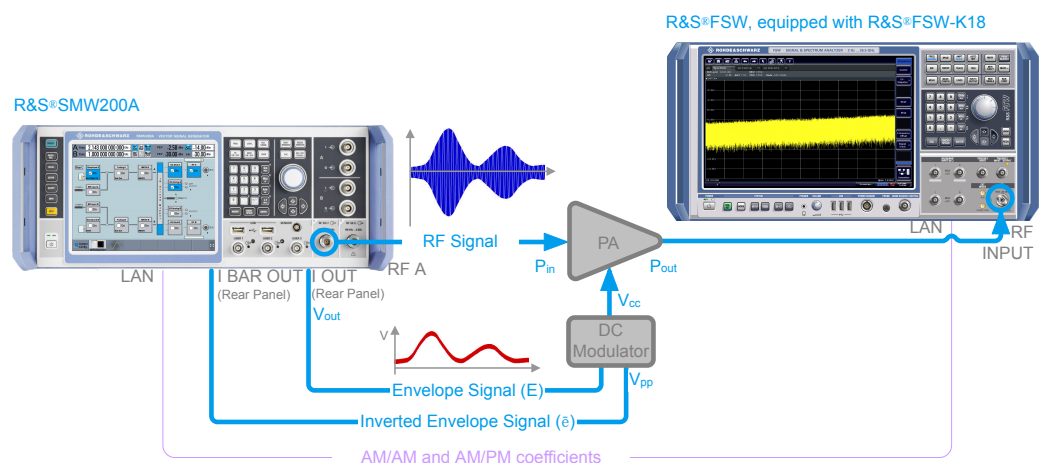

**Figure 5-1: Simplified test setup for power amplifier envelope tracking tests with DPD**

Use the following general guidelines:

1. Provide the output signal of the DUT to the R&S®FSW and measure the signal. Suitable RF measurements are the ACLR and EVM characteristics of the signal.



2. In the R&S SMW, select "I/Q Analog Outputs > Envelope Settings" and vary the "Envelope to RF Delay" to minimize the ACLR and EVM measured with the R&S®FSW.
3. Change the shaping method and shaping function and measure the power amplifier characteristics.  
Did its linearity and efficiency improved?
4. Use the R&S®FSW-K18 to evaluate the signal, calculate suitable predistortion values, and store the AM/AM and AM/PM tables.
5. Transfer the predistortion functions to R&S SMW and load them (select "I/Q Mod > AM/AM AM/PM > Predistortion Settings").  
See [Chapter 6, "How to Apply a Digital Predistortion to Improve the Efficiency of RF Power Amplifiers"](#), on page 74.
6. In the R&S®FSW, measure the power amplifier characteristics.  
Did its linearity improved?

## 6 How to Apply a Digital Predistortion to Improve the Efficiency of RF Power Amplifiers

Refer to [Figure 6-1](#) for an example of a simplified test setup for power amplifier testing with envelope tracking and digital predistortion. The illustration is intended to explain the principle in general, not all the connections and required equipment are considered.

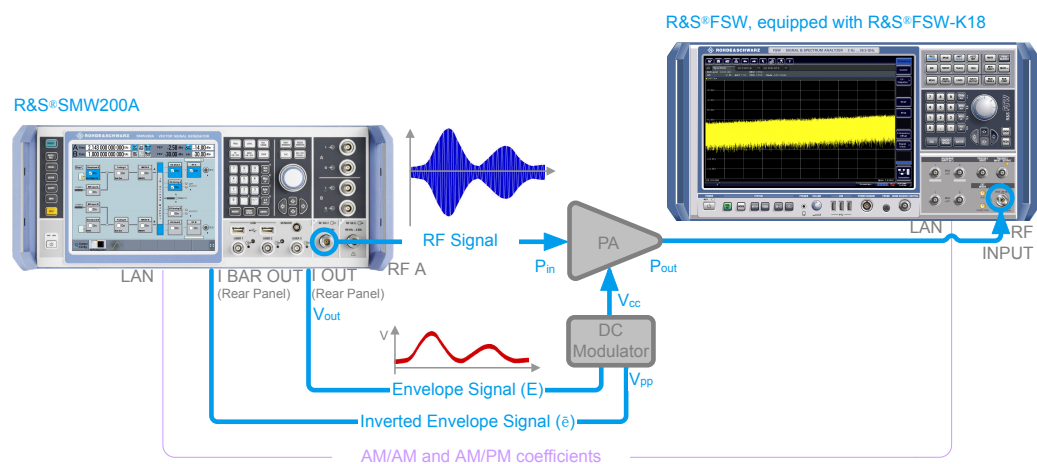

**Figure 6-1: Simplified test setup for power amplifier envelope tracking tests with DPD**

A real test setup comprises of the following equipment:

- R&S SMW to generate the RF signal, and to calculate and apply the DPD. In test setups for envelope tracking tests, the R&S SMW also generates the envelope tracking signal.
- R&S®FSW equipped with R&S®FSW-K18 Power Amplifier and Envelope Tracking Measurements to:
  - Measure and analyze the AM/AM and AM/PM predistortion
  - Calculate the AM/AM and AM/PM correction tables
  - Store and export the correction tables
- DUT, that is the power amplifier.
- Optional, R&S®RTO to monitor the generated envelope signal.

### General steps for tests to improve the efficiency of RF power amplifiers

Consider the following general steps:

1. Enable the R&S SMW to generate a baseband signal. A suitable baseband signal is a simple ramp function or, to minimize memory effects, a signal with small bandwidth.

2. Compare the input waveform to the output of the power amplifier and determine how the amplifier is distorting the signal.  
The normalized AM/AM and AM/PM curves show the variation of the magnitude and phase over the variation of the input power and thus provide a suitable representation and good basis for analysis.
3. A simple straightforward method to retrieve the DPD correction values is to "invert" the curves, see [Chapter 4.2.3, "Finding Out the Correction Values"](#), on page 52. Use the R&S®FSW-K18 to retrieve the AM/AM and AM/PM correction values automatically.
4. Use the retrieved correction values and define the predistortion functions.
5. Enable the AM/AM and AM/PM predistortion and predistort the original baseband signal.  
See ["To configure the R&S SMW to predistort the baseband signal"](#) on page 75
6. Measure the behavior of the power amplifier, for example perform EVM and ACP measurements or evaluate the AM/AM and AM/PM curves.  
  
Does the output signal of the DUT have a better performance with regards to ACP and/or EVM?

#### To configure the R&S SMW to predistort the baseband signal

1. Enable the R&S SMW to generate an EUTRA/LTE FDD DL signal.
2. Set "Frequency = 2.143 GHz" and "Level = -15 dB".
3. In the block diagram, select "I/Q Mod > Digital Predistortion > AM/AM, AM/PM", and perform the following:
  - a) Select "Digital Predistortion AM/AM, AM/PM > Predistortion Settings" and enable "Shaping > From Table".
  - b) Select "AM/AM Table > New", enter a file name, and select "AM/AM Table > Edit".
  - c) Enter the correction values and select "Save".  
See the example on [Figure 4-3](#).
  - d) Adjust the AM/PM correction values in the same way.
  - e) Select "Interpolation > Liner (Power)".
  - f) Select "Digital Predistortion AM/AM, AM/PM > General".
  - g) Select "Maximum Input Power  $PEP_{IN}$  Max > 3 dBm".
  - h) Select "AM/AM State > On", "AM/PM State > On" and "Predistortion State > On".
  - i) Select "Level Reference > After DPD", "Maximum Output Level Error = 0.1 dB" and "Maximum Number of Iterations = 3".
4. Enable "RF > State > On".
5. Trigger the signal generation

**To perform manual iterations to achieve a desired resulting signal level after the DPD**

To explain the iteration principle, we assume that the R&S SMW has been configured as described in "To configure the R&S SMW to predistort the baseband signal" on page 75 and the DPD uses an AM/AM predistortion function as shown on Figure 6-2.

To achieve a signal level of -15 dB after the DPD, perform the following steps and obey the rule:



Vary the "Level" with small steps.  
Always start with small value and increase the "Level" at the subsequent iterations.

1. Select "Digital Predistortion AM/AM, AM/PM > General > Level reference > Before DPD".

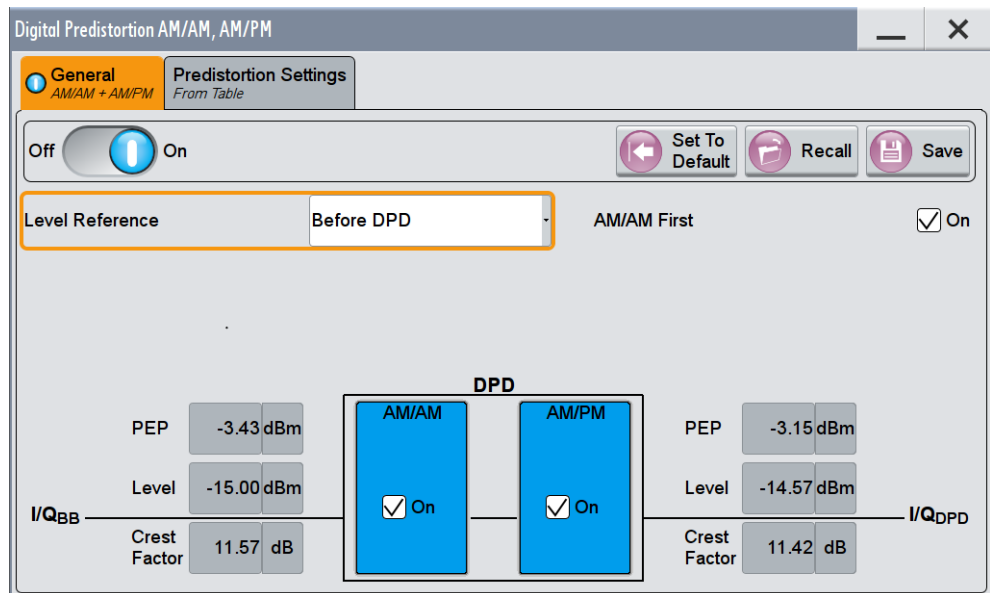

2. Calculate the  $\Delta_{P\_1}$ .

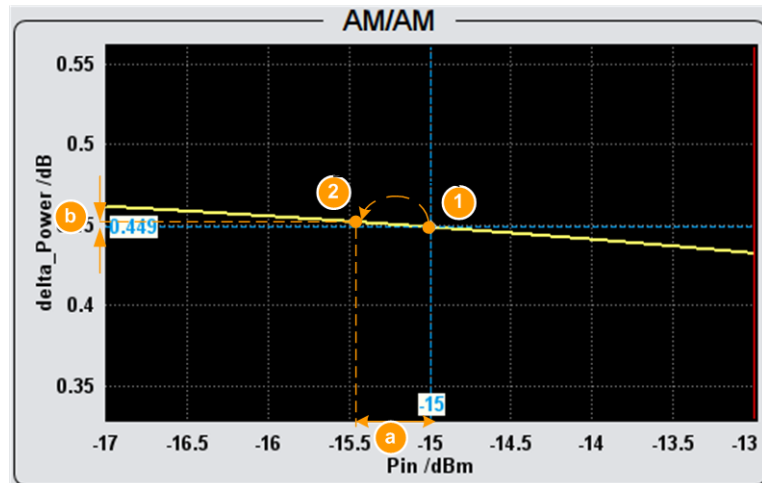

Figure 6-2: Manual iterations on an example AM/AM predistortion function ("Input Range PEP<sub>in</sub> = -17 dBm to -12 dBm"): Step#1

1 = current operating point:  $P_{IN} = Level_{IN\_1} = -15$  dBm

2 = first iteration with  $Level_{IN\_2}$

$a = \Delta_{P\_1}$

$b =$  difference between the correction values at the current and the new operating points

- $Level_{IN\_1} = Level = -15$  dBm
- $Level_{OUT\_1} = -15.42$  dBm
- $\Delta_{P\_1} = Level - Level_{OUT\_1} = -15 + 15.42 = 0.42$  dBm

3. Set the "Level" =  $Level + \Delta_{P\_1} = -15.45$  dBm.

The diagram displays the achieved output values;  $Level_{OUT\_2} = -15.02$  dBm.

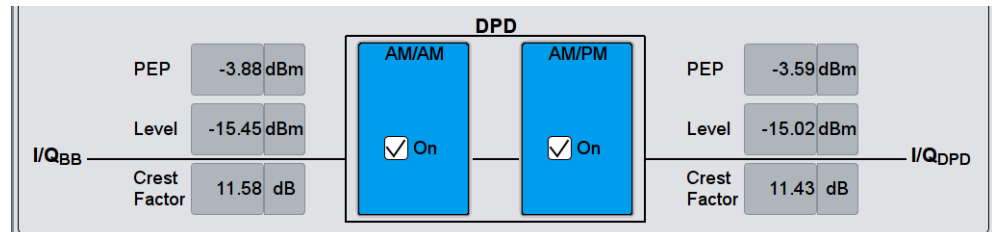

4. Calculate the  $\Delta_{P\_2}$ .



**A** Freq 2.143 000 000 000 GHz RF On Int Ref Mod On PEP -3.86 dBm Lev -15.43 dBm  
**B** Freq 1.000 000 000 000 GHz RF Off Mod Off PEP -30.00 dBm Lev -30.00 dBm

Digital Predistortion AM/AM, AM/PM A

General AM/AM + AM/PM Predistortion Settings From Table

Off  On Set To Default Recall Save

Level Reference Before DPD AM/AM First  On

**DPD**

PEP	-3.86 dBm	AM/AM	<input checked="" type="checkbox"/> On	AM/PM	<input checked="" type="checkbox"/> On	PEP	-3.57 dBm
Level	-15.43 dBm					Level	-15.00 dBm
Crest Factor	11.57 dB					Crest Factor	11.43 dB

I/Q<sub>BB</sub> I/Q<sub>DPD</sub>

System Config. EUTRALTE A AM/AM, AMPMA

6. Compare the operating point on the AM/AM functions.

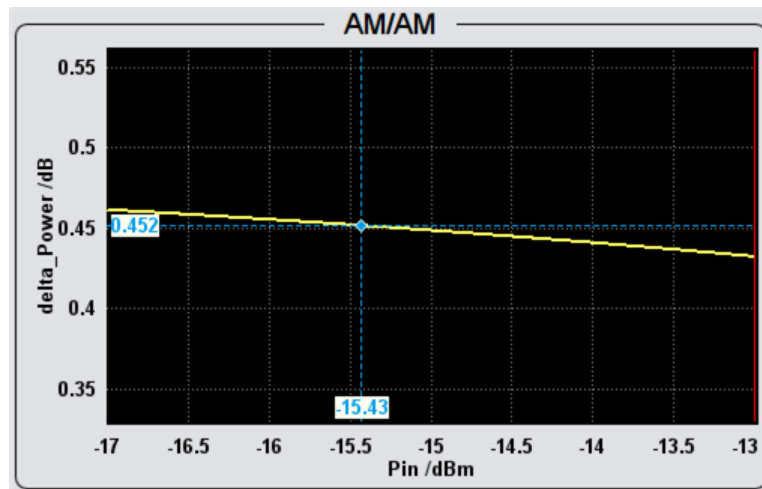

## 7 Remote-Control Commands

The following commands are required to perform signal generation with the R&S SMW-K540/-K541 options in a remote environment. We assume that the R&S SMW has already been set up for remote operation in a network as described in the R&S SMW user manual. A knowledge about the remote control operation and the SCPI command syntax are assumed.



### Conventions used in SCPI command descriptions

For a description of the conventions used in the remote command descriptions, see section "Remote Control Commands" in the R&S SMW user manual.

### Common Suffixes

The following common suffixes are used in remote commands:

Suffix	Value range	Description
SOURce<hw>	[1]4	Available baseband signals

### Programming Examples

The corresponding sections of the same title provide simple programming examples for the R&S SMW. The purpose of the examples is to present **all** commands for a given task. In real applications, one would rather reduce the examples to an appropriate subset of commands.

The programming examples have been tested with a software tool which provides an environment for the development and execution of remote tests. To keep the examples as simple as possible, only the "clean" SCPI syntax elements are reported. Non-executable command lines (e.g. comments) start with two // characters.

At the beginning of the most remote control program, an instrument (p)reset is recommended to set the R&S SMW to a definite state. The commands \*RST and SYSTem:PRESet are equivalent for this purpose. \*CLS also resets the status registers and clears the output buffer.

In all the examples we assume that a remote PC is connected to the instrument, the remote PC and the instrument are switched on, a connection between them is established and the security setting "System Config > Setup > Security > SCPI over LAN" is enabled.

The following commands specific to the R&S SMW-K540/-K541 options are described here:

- [SOURce:IQ:OUTPut Subsystem](#)..... 81
- [SOURce:IQ:OUTPut:ENVELOpe Commands](#).....83
- [SOURce:IQ:DPD Subsystem](#).....99



## 7.1 SOURce:IQ:OUTPut Subsystem

This section describes the commands of the output of an analog I/Q signal.

<code>[:SOURce&lt;hw&gt;]:IQ:OUTPut:ANALog:STATe</code> .....	81
<code>[:SOURce&lt;hw&gt;]:IQ:OUTPut[:ANALog]:PRESet</code> .....	81
<code>[:SOURce&lt;hw&gt;]:IQ:OUTPut[:ANALog]:SETTing:CATalog?</code> .....	81
<code>[:SOURce&lt;hw&gt;]:IQ:OUTPut[:ANALog]:SETTing:STORe</code> .....	82
<code>[:SOURce&lt;hw&gt;]:IQ:OUTPut[:ANALog]:SETTing:LOAD</code> .....	82
<code>[:SOURce&lt;hw&gt;]:IQ:OUTPut[:ANALog]:SETTing:DELeTe</code> .....	82
<code>[:SOURce&lt;hw&gt;]:IQ:OUTPut[:ANALog]:TYPE</code> .....	82

---

### `[:SOURce<hw>]:IQ:OUTPut:ANALog:STATe <State>`

Activates the specified analog I/Q output.

**Note:** By default, the output connectors I/Q OUT 1/2 are deactivated.

**Suffix:**

`:SOURce<hw>`            1|2  
 Determines the connectors, I/Q OUT 1 or I/Q OUT 2

**Parameters:**

`<State>`                    0 | 1 | OFF | ON  
 \*RST:                    0

**Example:**

`SOURce:IQ:OUTPut:ANALog:STATe ON`  
 activates the output of the analog I/Q signal on the I/Q OUT 1 connectors.

**Manual operation:** See "State" on page 23

---

### `[:SOURce<hw>]:IQ:OUTPut[:ANALog]:PRESet`

Sets the default settings (\*RST values specified for the commands).

Not affected is the state set with the command `[:SOURce<hw>]:IQ:OUTPut:ANALog:STATe`.

**Usage:**                    Event

**Manual operation:** See "Set to Default" on page 23

---

### `[:SOURce<hw>]:IQ:OUTPut[:ANALog]:SETTing:CATalog?`

Queries the files with I/Q output settings in the default directory. Listed are files with the file extension \*.iqout.

**Return values:**

`<Catalog>`                    "<filename1>,<filename2>,..."  
 Returns a string of file names separated by commas.

**Usage:**                    Query only

**Manual operation:** See ["Save/Recall"](#) on page 24

**[:SOURce<hw>]:IQ:OUTPut[:ANALog]:SETTing:STORe <Filename>**

Stores the current settings into the selected file; the file extension (\*.iqout) is assigned automatically.

**Setting parameters:**

<Filename> string

**Usage:** Setting only

**Manual operation:** See ["Save/Recall"](#) on page 24

**[:SOURce<hw>]:IQ:OUTPut[:ANALog]:SETTing:LOAD <Filename>**

Loads the selected file from the default or the specified directory. Loaded are files with extension \*.iqout.

**Setting parameters:**

<Filename> string

**Usage:** Setting only

**Manual operation:** See ["Save/Recall"](#) on page 24

**[:SOURce<hw>]:IQ:OUTPut[:ANALog]:SETTing:DELeTe <Filename>**

Deletes the selected file from the default or specified directory. Deleted are files with the file extension \*.iqout.

**Setting parameters:**

<Filename> string

**Usage:** Setting only

**Manual operation:** See ["Save/Recall"](#) on page 24

**[:SOURce<hw>]:IQ:OUTPut[:ANALog]:TYPE <Type>**

Determines the type of the analog signal.

**Parameters:**

<Type> SINGle | DIFFerential  
\*RST: SINGle

**Example:** SOURce1:IQ:OUTPut:ANALog:TYPE DIFFerential

**Manual operation:** See ["I/Q Output Type"](#) on page 25

## 7.2 SOURce:IQ:OUTPut:ENvelope Commands

The following remote control commands require software option R&S SMW-K540.

**Example: Generating an RF envelope signal and defining the shaping function**

```

*RST
// enable LTE signal
SOURcel:BB:EUTRa:SETTing:TMOD:DL "E-TM1_1__5MHz"
SOURcel:BB:EUTRa:STATe 1

// define the RF level and frequency
SOURcel:FREQuency:CW 214300000
SOURcel:POWer:LEVel:IMMediate:AMPLitude -15
SOURcel:POWer:LEVel:IMMediate:OFFSet 0.5
SOURcel:CORRection:VALue?
// Response: 1

// enable RF envelope generation and define the settings
SOURcel:IQ:OUTPut:ANALog:ENVELOpe:STATe 1
SOURcel:IQ:OUTPut:ANALog:ENVELOpe:ADAPtion AUTO
SOURcel:IQ:OUTPut:ANALog:TYPE DIFF
SOURcel:IQ:OUTPut:ANALog:ENVELOpe:ETRAk USER
SOURcel:IQ:OUTPut:ANALog:ENVELOpe:VREF VCC
SOURcel:IQ:OUTPut:ANALog:ENVELOpe:POWer:OFFSet?
// Response: 1.5

SOURcel:IQ:OUTPut:ANALog:ENVELOpe:VPP:MAX 4
SOURcel:IQ:OUTPut:ANALog:ENVELOpe:GAIN 0
SOURcel:IQ:OUTPut:ANALog:ENVELOpe:EMF:STATe 1
SOURcel:IQ:OUTPut:ANALog:ENVELOpe:RIN 50
SOURcel:IQ:OUTPut:ANALog:ENVELOpe:TERMination GROund
SOURcel:IQ:OUTPut:ANALog:ENVELOpe:BINPut 1
SOURcel:IQ:OUTPut:ANALog:ENVELOpe:VCC:OFFSet 2

SOURcel:IQ:OUTPut:ANALog:ENVELOpe:VCC:MIN 0.5
SOURcel:IQ:OUTPut:ANALog:ENVELOpe:VCC:MAX 2.5

SOURcel:IQ:OUTPut:ANALog:ENVELOpe:BIAS 0
SOURcel:IQ:OUTPut:ANALog:ENVELOpe:OFFSet -2
SOURcel:IQ:OUTPut:ANALog:ENVELOpe:VOUt:MAX?
// Response: 0.5
SOURcel:IQ:OUTPut:ANALog:ENVELOpe:VOUt:MIN?
// Response: -1.5

SOURcel:IQ:OUTPut:ANALog:ENVELOpe:PIN:MIN -30
SOURcel:IQ:OUTPut:ANALog:ENVELOpe:PIN:MAX 0

SOURcel:IQ:OUTPut:ANALog:ENVELOpe:DELay 0.0000000001
SOURcel:IQ:OUTPut:ANALog:ENVELOpe:FDPD OFF

// enable envelope shaping
// SOURcel:IQ:OUTPut:ANALog:ENVELOpe:SHAPing:MODE DETR
// SOURcel:IQ:OUTPut:ANALog:ENVELOpe:SHAPing:DETRoughing:FUNCTion F3
// SOURcel:IQ:OUTPut:ANALog:ENVELOpe:SHAPing:DETRoughing:COUPLing OFF

```

## SOURce:IQ:OUTPut:ENVELOpe Commands

```

// SOURce:IQ:OUTPut:ANALog:ENVELOpe:SHAPing:DETRoughing:FACTOR 0.225
// SOURce:IQ:OUTPut:ANALog:ENVELOpe:SHAPing:DETRoughing:PEXponent 1

// quering the oprating point level, current PEP and levels
// SOURce:IQ:OUTPut:ANALog:ENVELOpe:ADAPtion?
// Response: Auto
// SOURce:IQ:OUTPut:ANALog:ENVELOpe:VCC:VALue:LEVel?
// Response: 0.927
// SOURce:IQ:OUTPut:ANALog:ENVELOpe:VCC:VALue:PEP?
// Response: 1.922
// SOURce:IQ:OUTPut:ANALog:ENVELOpe:VCC:VALue? 1,NORM,VOLT
// Response: 2.5
// SOURce:IQ:OUTPut:ANALog:ENVELOpe:VCC:VALue? 0,NORM,VOLT
// Response: 0.563
// SOURce:IQ:OUTPut:ANALog:ENVELOpe:PIN:MAX?
// Response: 0
// SOURce:IQ:OUTPut:ANALog:ENVELOpe:PIN:MIN?
// response: -30
// SOURce:IQ:OUTPut:ANALog:ENVELOpe:VCC:VALue? 0,DBM,POW
// Response: 2.5
// SOURce:IQ:OUTPut:ANALog:ENVELOpe:VCC:VALue? -30,DBM,POW
// Response: 0.563

SOURce:IQ:OUTPut:ANALog:ENVELOpe:SHAPing:MODE TABL
SOURce:IQ:OUTPut:ANALog:ENVELOpe:SHAPing:PV:FILE:CATALog?
// Response: myLUT_pv
SOURce:IQ:OUTPut:ANALog:ENVELOpe:SHAPing:PV:FILE:SElect "/var/user/myLUT_pv.iq_lutpv"
SOURce:IQ:OUTPut:ANALog:ENVELOpe:SHAPing:INTerp LIN
SOURce:IQ:OUTPut:ANALog:ENVELOpe:SHAPing:SCALE PWeR

// change the envelope shaping mode
SOURce:IQ:OUTPut:ANALog:ENVELOpe:SHAPing:MODE POLY
// query files with polynomial functions in the default user directory
SOURce:IQ:OUTPut:ANALog:ENVELOpe:SHAPing:COEFFicients:CATALog?
// Response: env_poly_evm,myPoly
SOURce:IQ:OUTPut:ANALog:ENVELOpe:SHAPing:COEFFicients:LOAD "myPoly"
SOURce:IQ:OUTPut:ANALog:ENVELOpe:SHAPing:COEFFicients?
// Response: 0.135,0.82
SOURce:IQ:OUTPut:ANALog:ENVELOpe:SHAPing:COEFFicients 0.135,0.83
SOURce:IQ:OUTPut:ANALog:ENVELOpe:SHAPing:COEFFicients:STORE "/var/user/myPoly.iq_poly"

// enable the outputs
SOURce:IQ:OUTPut:ANALog:STATe 1
OUTPut1:STATe 1

// store the settings
MMEMory:CDIRectory "/var/user/setups"
SOURce:IQ:OUTPut:ANALog:SETTings:CATALog?
// Response: etrak_v1-2
SOURce:IQ:OUTPut:ANALog:SETTings:STORE "my_ET"

```

## SOURce:IQ:OUTPut:ENVELOpe Commands

```

SOURce1:IQ:OUTPut:ANALog:PREset
// change the envelope voltage adaptation mode
SOURce1:IQ:OUTPut:ANALog:ENVELOpe:ADAPtion MAN

SOURce1:IQ:OUTPut:LEVel 4

SOURce1:IQ:OUTPut:ANALog:ENVELOpe:SHAPing:GAIN:PRE -3
SOURce1:IQ:OUTPut:ANALog:ENVELOpe:SHAPing:GAIN:POST 2.5

// change the envelope shaping mode
SOURce1:IQ:OUTPut:ANALog:ENVELOpe:SHAPing:MODE TABL
SOURce1:IQ:OUTPut:ANALog:ENVELOpe:SHAPing:FILE:CATalog?
// Response: myLUT_vv
SOURce1:IQ:OUTPut:ANALog:ENVELOpe:SHAPing:FILE:SElect "/var/user/myLUT_vv.iq_lut"

// set the shaping values in raw format
// SOURce1:IQ:OUTPut[:ANALog]:ENVELOpe:SHAPing:FILE:DATA 0,0, 0.1,0.2, 1,1
// SOURce1:IQ:OUTPut[:ANALog]:ENVELOpe:SHAPing:FILE:CATalog?
// Response: myLUT_vv
// set the shaping values and store them into a file
// SOURce1:IQ:OUTPut[:ANALog]:ENVELOpe:SHAPing:FILE:NEW "LUT_vv_raw", 0,0, 0.1,0.2, 1,1.5
// SOURce1:IQ:OUTPut[:ANALog]:ENVELOpe:SHAPing:FILE:CATalog?
// Response: myLUT_vv, LUT_vv_raw

```

[SOURce<hw>]:IQ:OUTPut[:ANALog]:ENVELOpe:STATE.....	87
[SOURce<hw>]:IQ:OUTPut[:ANALog]:ENVELOpe:ADAPtion.....	87
[SOURce<hw>]:IQ:OUTPut[:ANALog]:ENVELOpe:ETRAk.....	88
[SOURce<hw>]:IQ:OUTPut[:ANALog]:ENVELOpe:VREF.....	88
[SOURce<hw>]:IQ:OUTPut[:ANALog]:ENVELOpe:DELay.....	88
[SOURce<hw>]:IQ:OUTPut[:ANALog]:ENVELOpe:FDPD.....	88
[SOURce<hw>]:IQ:OUTPut[:ANALog]:ENVELOpe:VOU:MIN.....	89
[SOURce<hw>]:IQ:OUTPut[:ANALog]:ENVELOpe:VOU:MAX.....	89
[SOURce<hw>]:IQ:OUTPut[:ANALog]:ENVELOpe:BIAS.....	89
[SOURce<hw>]:IQ:OUTPut[:ANALog]:ENVELOpe:OFFSet.....	89
[SOURce<hw>]:IQ:OUTPut[:ANALog]:ENVELOpe:VPP[:MAX].....	90
[SOURce<hw>]:IQ:OUTPut[:ANALog]:ENVELOpe:EMF[:STATE].....	90
[SOURce<hw>]:IQ:OUTPut[:ANALog]:ENVELOpe:RIN.....	90
[SOURce<hw>]:IQ:OUTPut[:ANALog]:ENVELOpe:TERMination.....	90
[SOURce<hw>]:IQ:OUTPut[:ANALog]:ENVELOpe:BINPut.....	91
[SOURce<hw>]:IQ:OUTPut[:ANALog]:ENVELOpe:GAIN.....	91
[SOURce<hw>]:IQ:OUTPut[:ANALog]:ENVELOpe:VCC:OFFSet.....	91
[SOURce<hw>]:IQ:OUTPut[:ANALog]:ENVELOpe:VCC:MIN.....	92
[SOURce<hw>]:IQ:OUTPut[:ANALog]:ENVELOpe:VCC:MAX.....	92
[SOURce<hw>]:IQ:OUTPut[:ANALog]:ENVELOpe:VCC:VALue:PEP?.....	92
[SOURce<hw>]:IQ:OUTPut[:ANALog]:ENVELOpe:VCC:VALue:LEVel?.....	92
[SOURce<hw>]:IQ:OUTPut[:ANALog]:ENVELOpe:VCC:VALue?.....	93
[SOURce<hw>]:IQ:OUTPut[:ANALog]:ENVELOpe:PIN:MIN.....	93
[SOURce<hw>]:IQ:OUTPut[:ANALog]:ENVELOpe:PIN:MAX.....	93
[SOURce<hw>]:IQ:OUTPut[:ANALog]:ENVELOpe:POWer:OFFSet?.....	94

<code>[:SOURce&lt;hw&gt;]:IQ:OUTPut[:ANALog]:ENVELOpe:SHAPing:MODE</code> .....	94
<code>[:SOURce&lt;hw&gt;]:IQ:OUTPut[:ANALog]:ENVELOpe:SHAPing:SCALE</code> .....	94
<code>[:SOURce&lt;hw&gt;]:IQ:OUTPut[:ANALog]:ENVELOpe:SHAPing:GAIN:PRE</code> .....	95
<code>[:SOURce&lt;hw&gt;]:IQ:OUTPut[:ANALog]:ENVELOpe:SHAPing:GAIN:POST</code> .....	95
<code>[:SOURce&lt;hw&gt;]:IQ:OUTPut[:ANALog]:ENVELOpe:SHAPing:FILE:CATalog?</code> .....	95
<code>[:SOURce&lt;hw&gt;]:IQ:OUTPut[:ANALog]:ENVELOpe:SHAPing:PV:FILE:CATalog?</code> .....	95
<code>[:SOURce&lt;hw&gt;]:IQ:OUTPut[:ANALog]:ENVELOpe:SHAPing:FILE[:SELEct]</code> .....	95
<code>[:SOURce&lt;hw&gt;]:IQ:OUTPut[:ANALog]:ENVELOpe:SHAPing:PV:FILE[:SELEct]</code> .....	95
<code>[:SOURce&lt;hw&gt;]:IQ:OUTPut[:ANALog]:ENVELOpe:SHAPing:FILE:DATA</code> .....	96
<code>[:SOURce&lt;hw&gt;]:IQ:OUTPut[:ANALog]:ENVELOpe:SHAPing:PV:FILE:DATA</code> .....	96
<code>[:SOURce&lt;hw&gt;]:IQ:OUTPut[:ANALog]:ENVELOpe:SHAPing:FILE:NEW</code> .....	96
<code>[:SOURce&lt;hw&gt;]:IQ:OUTPut[:ANALog]:ENVELOpe:SHAPing:PV:FILE:NEW</code> .....	96
<code>[:SOURce&lt;hw&gt;]:IQ:OUTPut[:ANALog]:ENVELOpe:SHAPing:INTerp</code> .....	96
<code>[:SOURce&lt;hw&gt;]:IQ:OUTPut[:ANALog]:ENVELOpe:SHAPing:COEFFicients</code> .....	97
<code>[:SOURce&lt;hw&gt;]:IQ:OUTPut[:ANALog]:ENVELOpe:SHAPing:COEFFicients:CATalog?</code> .....	97
<code>[:SOURce&lt;hw&gt;]:IQ:OUTPut[:ANALog]:ENVELOpe:SHAPing:COEFFicients:STORE</code> .....	97
<code>[:SOURce&lt;hw&gt;]:IQ:OUTPut[:ANALog]:ENVELOpe:SHAPing:COEFFicients:LOAD</code> .....	97
<code>[:SOURce&lt;hw&gt;]:IQ:OUTPut[:ANALog]:ENVELOpe:SHAPing:DETRoughing:FUNCTion</code> .....	98
<code>[:SOURce&lt;hw&gt;]:IQ:OUTPut[:ANALog]:ENVELOpe:SHAPing:DETRoughing:COUPling</code> .....	98
<code>[:SOURce&lt;hw&gt;]:IQ:OUTPut[:ANALog]:ENVELOpe:SHAPing:DETRoughing:FACTor</code> .....	98
<code>[:SOURce&lt;hw&gt;]:IQ:OUTPut[:ANALog]:ENVELOpe:SHAPing:DETRoughing:PEXPonent</code> .....	98

---

#### `[:SOURce<hw>]:IQ:OUTPut[:ANALog]:ENVELOpe:STATE` <State>

Enables the output of a control signal that follows the RF envelope.

##### Parameters:

<State>            0 | 1 | OFF | ON  
 \*RST:            0

**Example:**            see [Example "Generating an RF envelope signal and defining the shaping function"](#) on page 84

**Manual operation:**    See ["RF Envelope"](#) on page 24

---

#### `[:SOURce<hw>]:IQ:OUTPut[:ANALog]:ENVELOpe:ADAPtion` <AdaptionMode>

Defines the envelope voltage adaption mode.

##### Parameters:

<AdaptionMode>    AUTO | MANual | POWER  
 AUTO = Auto Normalized, POWER = Auto Power, MANual = Manual  
 \*RST:            AUTO

**Example:**            See [Example "Generating an RF envelope signal and defining the shaping function"](#) on page 84

**Manual operation:**    See ["Envelope Voltage Adaptation"](#) on page 24

---

**[:SOURce<hw>]:IQ:OUTPut[:ANALog]:ENVELOpe:ETRAk <ETRAkfcType>**

Selects one of the predefined interface types or allows user-defined settings.

See [Table 3-1](#).

**Parameters:**

<ETRAkfcType> USER | E1V2 | E1V5 | E2V0  
 \*RST: USER

**Example:** SOURce1:IQ:OUTPut:ANALog:ENVELOpe:ETRAk E2V0

**Manual operation:** See "[eTrak® Interface Type](#)" on page 25

---

**[:SOURce<hw>]:IQ:OUTPut[:ANALog]:ENVELOpe:VREF <VoltageReferenc>**

Defines whether the envelope voltage  $V_{out}$  is set directly or it is estimated from the selected supply voltage  $V_{cc}$ .

**Parameters:**

<VoltageReferenc> VCC | VOUT  
 \*RST: VCC

**Example:** see [Example "Generating an RF envelope signal and defining the shaping function"](#) on page 84

**Manual operation:** See "[Envelope Voltage Reference](#)" on page 25

---

**[:SOURce<hw>]:IQ:OUTPut[:ANALog]:ENVELOpe:DELAy <Delay>**

Enables a time delay of the generated envelope signal relative to the corresponding RF signal.

**Parameters:**

<Delay> float  
 Range: -500E-9 to 500E-9  
 Increment: 1E-12  
 \*RST: 0

**Example:** see [Example "Generating an RF envelope signal and defining the shaping function"](#) on page 84

**Manual operation:** See "[Envelope to RF Delay](#)" on page 32

---

**[:SOURce<hw>]:IQ:OUTPut[:ANALog]:ENVELOpe:FDPD <CalcFromDpdStat>**

Enables calculation of the envelope from predistorted signal.

**Parameters:**

<CalcFromDpdStat> 0 | 1 | OFF | ON  
 \*RST: 0



**Example:** see [Example "Generating an RF envelope signal and defining the shaping function"](#) on page 84

**Options:** R&S SMW-K540/K541

**Manual operation:** See ["Calculate Envelope form Predistorted Signal"](#) on page 32

**[ :SOURce<hw>]:IQ:OUTPut[:ANALog]:ENVELOpe:VOUT:MIN <VoutMin>**  
**[ :SOURce<hw>]:IQ:OUTPut[:ANALog]:ENVELOpe:VOUT:MAX <VoutMax>**

Queries the minimum and maximum values of the estimated envelope output voltage  $V_{out}$ .

**Parameters:**

<VoutMax> float  
 Range: 0.04 to 8  
 Increment: 1E-3  
 \*RST: 1

**Example:** see [Example "Generating an RF envelope signal and defining the shaping function"](#) on page 84

**Manual operation:** See ["V<sub>out</sub>Min/Max"](#) on page 25

**[ :SOURce<hw>]:IQ:OUTPut[:ANALog]:ENVELOpe:BIAS <Bias>**

Sets a bias.

**Parameters:**

<Bias> float  
 Range: -4 to 4  
 Increment: 1E-4  
 \*RST: 0

**Example:** see [Example "Generating an RF envelope signal and defining the shaping function"](#) on page 84

**Manual operation:** See ["Bias"](#) on page 26

**[ :SOURce<hw>]:IQ:OUTPut[:ANALog]:ENVELOpe:OFFSet <Offset>**

Sets an offset between the envelope and the inverted envelope signal.

**Parameters:**

<Offset> float  
 Range: -4 to 4  
 Increment: 1E-4  
 \*RST: 0  
 Default unit: mV

**Example:** see [Example "Generating an RF envelope signal and defining the shaping function"](#) on page 84

**Manual operation:** See ["Offset"](#) on page 26

---

**[:SOURce<hw>]:IQ:OUTPut[:ANALog]:ENVELOpe:VPP[:MAX] <VppMax>**

Set the maximum value of the driving voltage  $V_{pp}$  of the used external DC modulator.

**Parameters:**

<VppMax> float  
 Range: 0.04 to 8  
 Increment: 1E-3  
 \*RST: 1

**Example:** see [Example "Generating an RF envelope signal and defining the shaping function"](#) on page 84

**Manual operation:** See ["V<sub>pp</sub>Max"](#) on page 29

---

**[:SOURce<hw>]:IQ:OUTPut[:ANALog]:ENVELOpe:EMF[:STATe] <EmfState>**

Defines whether the EMF or the voltage value is used.

**Parameters:**

<EmfState> 0 | 1 | OFF | ON  
 \*RST: 1

**Example:** see [Example "Generating an RF envelope signal and defining the shaping function"](#) on page 84

**Manual operation:** See ["EMF"](#) on page 27

---

**[:SOURce<hw>]:IQ:OUTPut[:ANALog]:ENVELOpe:RIN <InputResistance>**

Sets the input impedance  $R_{in}$  of the used external DC modulator.

**Parameters:**

<InputResistance> float  
 Range: 50|100 to 1E6  
 Increment: 0.1  
 \*RST: 50

**Example:** see [Example "Generating an RF envelope signal and defining the shaping function"](#) on page 84

**Manual operation:** See ["R<sub>in</sub>"](#) on page 27

---

**[:SOURce<hw>]:IQ:OUTPut[:ANALog]:ENVELOpe:TERMination <Termination>**

Sets how the inputs of the DC modulator are terminated.

**Parameters:**

<Termination> GROund | WIRE  
 \*RST: GROund

**Example:** See [Example "Generating an RF envelope signal and defining the shaping function"](#) on page 84

**Manual operation:** See ["Termination"](#) on page 27

**[:SOURce<hw>]:IQ:OUTPut[:ANALog]:ENVELOpe:BINPut <BipolarInput>**

Enables the generation of a bipolar signal.

**Parameters:**

<BipolarInput> 0 | 1 | OFF | ON  
\*RST: 0

**Example:** see [Example "Generating an RF envelope signal and defining the shaping function"](#) on page 84

**Manual operation:** See ["Bipolar Input"](#) on page 28

**[:SOURce<hw>]:IQ:OUTPut[:ANALog]:ENVELOpe:GAIN <Gain>**

Sets the gain of the used external DC modulator.

**Parameters:**

<Gain> float  
Range: -50 to 50  
Increment: 0.01  
\*RST: 0

**Example:** see [Example "Generating an RF envelope signal and defining the shaping function"](#) on page 84

**Manual operation:** See ["Gain"](#) on page 29

**[:SOURce<hw>]:IQ:OUTPut[:ANALog]:ENVELOpe:VCC:OFFSet <VccOffset>**

Applies a voltage offset on the supply voltage  $V_{cc}$ .

**Parameters:**

<VccOffset> float  
Range: 0 to 10  
Increment: 1E-3  
\*RST: 0  
Default unit: mV

**Example:** see [Example "Generating an RF envelope signal and defining the shaping function"](#) on page 84

**Manual operation:** See ["V<sub>cc</sub>Offset"](#) on page 29

---

```
[:SOURce<hw>]:IQ:OUTPut[:ANALog]:ENVELOpe:VCC:MIN <VccMin>
[:SOURce<hw>]:IQ:OUTPut[:ANALog]:ENVELOpe:VCC:MAX <VccMax>
```

Sets the maximum value of the supply voltage  $V_{cc}$ .

**Parameters:**

```
<VccMax>          float
                  Range:    0.04 to 8
                  Increment: 0.001
                  *RST:     1
```

**Example:** see [Example "Generating an RF envelope signal and defining the shaping function"](#) on page 84

**Manual operation:** See "[V<sub>cc</sub>Min/Max](#)" on page 30

---

```
[:SOURce<hw>]:IQ:OUTPut[:ANALog]:ENVELOpe:VCC:VALue:PEP?
```

Queries the  $V_{cc}$  value of the current PEP of the generated RF signal.

**Return values:**

```
<VccForCrtPep>    float
                  Range:    0 to 38
                  Increment: 1E-3
                  *RST:     0
```

**Example:** see [Example "Generating an RF envelope signal and defining the shaping function"](#) on page 84

**Usage:** Query only

**Manual operation:** See "[Diagram](#)" on page 41

---

```
[:SOURce<hw>]:IQ:OUTPut[:ANALog]:ENVELOpe:VCC:VALue:LEVel?
```

Queries the  $V_{cc}$  value of the current RMS power level (operating point).

**Return values:**

```
<VccForRfLevel>  float
                  Range:    0 to 38
                  Increment: 1E-3
                  *RST:     0
```

**Example:** see [Example "Generating an RF envelope signal and defining the shaping function"](#) on page 84

**Usage:** Query only

**Manual operation:** See "[Diagram](#)" on page 41

---

**[:SOURce<hw>]:IQ:OUTPut[:ANALog]:ENVELOpe:VCC:VALue? <xValue>, <xUnit>, <xScale>**

Queries the  $V_{CC}$  value for the selected <xValue>.

**Query parameters:**

<xValue> float  
Value on the x-axis  
Value range depends on the selected "Envelope Voltage Adaptation" and  $PEP_{inMin}$  and  $PEP_{inMax}$  values.

<xUnit> NORMALized | DBM | V  
\*RST: NORMALized

<xScale> VOLTage | POWer  
\*RST: VOLTage

**Return values:**

<VccValue> float  
Range: 0 to 38  
Increment: 1E-3  
\*RST: 0

**Example:** see [Example "Generating an RF envelope signal and defining the shaping function"](#) on page 84

**Usage:** Query only

**Manual operation:** See ["Diagram"](#) on page 41

---

**[:SOURce<hw>]:IQ:OUTPut[:ANALog]:ENVELOpe:PIN:MIN <PinMin>**

Sets the minimum value of the input power  $P_{in}$ .

**Parameters:**

<PinMin> float  
Range: -145 to 20  
Increment: 0.01  
\*RST: -30

**Example:** see [Example "Generating an RF envelope signal and defining the shaping function"](#) on page 84

**Manual operation:** See ["PEP<sub>in</sub>Min/Max"](#) on page 30

---

**[:SOURce<hw>]:IQ:OUTPut[:ANALog]:ENVELOpe:PIN:MAX <PinMax>**

Sets the maximum value of the input power  $P_{in}$ .

**Parameters:**

<PinMax> float  
 Range: -145 to 20  
 Increment: 0.01  
 \*RST: -20

**Example:** see [Example "Generating an RF envelope signal and defining the shaping function"](#) on page 84

**Manual operation:** See ["PEP<sub>in</sub>Min/Max"](#) on page 30

**[[:SOURce<hw>]:IQ:OUTPut[:ANALog]:ENVelope:POWer:OFFSet?**

Queries the current power offset, that is the sum of enabled "RF Level > Offset" and "User Correction".

**Return values:**

<PowerOffset> float  
 Range: -200 to 200  
 Increment: 0.01  
 \*RST: 0

**Example:** see [Example "Generating an RF envelope signal and defining the shaping function"](#) on page 84

**Usage:** Query only

**Manual operation:** See ["Power Offset"](#) on page 30

**[[:SOURce<hw>]:IQ:OUTPut[:ANALog]:ENVelope:SHAPing:MODE  
<ShapingMode>**

Enables envelope shaping and selects the method to define the shaping function.

**Parameters:**

<ShapingMode> OFF | LINear | TABLE | POLYnomial | DETRoughing | POWer  
 LINear = Linear (Voltage)  
 POWer = Linear (Power)  
 \*RST: OFF

**Example:** see [Example "Generating an RF envelope signal and defining the shaping function"](#) on page 84

**Manual operation:** See ["Shaping"](#) on page 34

**[[:SOURce<hw>]:IQ:OUTPut[:ANALog]:ENVelope:SHAPing:SCALE <Scale>**

Determines the units used on the x and y axis.

**Parameters:**

<Scale> POWer | VOLTage  
 \*RST: VOLTage

**Example:** see [Example "Generating an RF envelope signal and defining the shaping function"](#) on page 84

**Manual operation:** See ["Scale"](#) on page 41

```
[ :SOURce<hw> ]:IQ:OUTPut[:ANALog]:ENVELOpe:SHAPing:GAIN:PRE <PreGain>
[ :SOURce<hw> ]:IQ:OUTPut[:ANALog]:ENVELOpe:SHAPing:GAIN:POST
  <PostGain>
```

Sets a post-gain.

**Parameters:**

<PostGain>	float
Range:	-3 to 20
Increment:	1E-2
*RST:	0

**Example:** see [Example "Generating an RF envelope signal and defining the shaping function"](#) on page 84

**Manual operation:** See ["Post-Gain"](#) on page 39

```
[ :SOURce<hw> ]:IQ:OUTPut[:ANALog]:ENVELOpe:SHAPing:FILE:CATalog?
[ :SOURce<hw> ]:IQ:OUTPut[:ANALog]:ENVELOpe:SHAPing:PV:FILE:CATalog?
```

Queries the available table shaping files in the default directory. Only files with the file extension \*.iq\_lut or \*.iq\_lutpv are listed.

**Example:** see [Example "Generating an RF envelope signal and defining the shaping function"](#) on page 84

**Usage:** Query only

**Manual operation:** See ["Shaping Table"](#) on page 39

```
[ :SOURce<hw> ]:IQ:OUTPut[:ANALog]:ENVELOpe:SHAPing:FILE[:SElect]
  <Filename>
[ :SOURce<hw> ]:IQ:OUTPut[:ANALog]:ENVELOpe:SHAPing:PV:FILE[:SElect]
  <Filename>
```

Selects an envelope shaping file (extension \*.iq\_lut or \*.iq\_lutpv).

**Parameters:**

<Filename>	string
------------	--------

**Example:** see [Example "Generating an RF envelope signal and defining the shaping function"](#) on page 84

**Manual operation:** See ["Shaping Table"](#) on page 39

---

```
[:SOURce<hw>]:IQ:OUTPut[:ANALog]:ENVELOpe:SHAPing:FILE:DATA <Vin/  
Vmax>,<Vcc/Vmax>[,<Vin/Vmax>,<Vcc/Vmax>...]
```

```
[:SOURce<hw>]:IQ:OUTPut[:ANALog]:ENVELOpe:SHAPing:PV:FILE:DATA  
<P>,<Vcc>[,<P>,<Vcc>, ...]
```

Defines the shaping function in a raw data format.

See also `[ :SOURce<hw> ] :IQ:OUTPut [ :ANALog ] :ENVELOpe:SHAPing:PV:FILE:NEW` on page 96.

**Parameters:**

<P>,<Vcc>                      Sequence of up to 4000 comma-separated value pairs.

**Example:**                      See [Example "Generating an RF envelope signal and defining the shaping function"](#) on page 84

---

```
[:SOURce<hw>]:IQ:OUTPut[:ANALog]:ENVELOpe:SHAPing:FILE:NEW  
<Filename>,<Vin/Vmax>,<Vcc/Vmax>
```

```
[:SOURce<hw>]:IQ:OUTPut[:ANALog]:ENVELOpe:SHAPing:PV:FILE:NEW  
<Filename>,<P>,<Vcc>
```

Stores the shaping values into a file with the selected file name and loads it.

The file is stored in the default directory or in the directory specified with the absolute file path. If the file does not yet exist, a new file is created. The file extension is assigned automatically.

**Setting parameters:**

<Filename>                      string

<P>,<Vcc>                      value pairs

**Example:**                      see [Example "Generating an RF envelope signal and defining the shaping function"](#) on page 84

**Usage:**                          Setting only

---

```
[:SOURce<hw>]:IQ:OUTPut[:ANALog]:ENVELOpe:SHAPing:INTerp <Interpolation>
```

For envelope shaping with shaping tables, enables linear interpolation.

**Parameters:**

<Interpolation>                OFF | LINear | POWer

LINear = Linear (Voltage)

POWer = Linear (Power)

\*RST:                          OFF

**Example:**                      see [Example "Generating an RF envelope signal and defining the shaping function"](#) on page 84

**Manual operation:**        See ["Interpolation"](#) on page 40



---

**[[:SOURce<hw>]:IQ:OUTPut[:ANALog]:ENVELOpe:SHAPing:COEFFicients**

Sets the polynomial coefficients.

**Example:** see [Example "Generating an RF envelope signal and defining the shaping function"](#) on page 84

**Manual operation:** See ["Polynomial Order"](#) on page 45  
See ["Polynomial constant and coefficients"](#) on page 45  
See ["Apply, OK"](#) on page 45

---

**[[:SOURce<hw>]:IQ:OUTPut[:ANALog]:ENVELOpe:SHAPing:COEFFicients:CATalog?**

Queries the available polynomial files in the default directory. Only files with the file extension \*.iq\_poly are listed.

**Example:** see [Example "Generating an RF envelope signal and defining the shaping function"](#) on page 84

**Usage:** Query only

**Manual operation:** See ["Save/Recall Polynomial"](#) on page 45

---

**[[:SOURce<hw>]:IQ:OUTPut[:ANALog]:ENVELOpe:SHAPing:COEFFicients:STORE<Filename>**

Saves the polynomial function as polynomial file.

**Setting parameters:**

<Filename> string

**Example:** see [Example "Generating an RF envelope signal and defining the shaping function"](#) on page 84

**Usage:** Setting only

**Manual operation:** See ["Save/Recall Polynomial"](#) on page 45

---

**[[:SOURce<hw>]:IQ:OUTPut[:ANALog]:ENVELOpe:SHAPing:COEFFicients:LOAD<Filename>**

Loads the selected polynomial file.

**Setting parameters:**

<Filename> string

**Example:** see [Example "Generating an RF envelope signal and defining the shaping function"](#) on page 84

**Usage:** Setting only

**Manual operation:** See ["Save/Recall Polynomial"](#) on page 45

---

**[:SOURce<hw>]:IQ:OUTPut[:ANALog]:ENVELOpe:SHAPing:DETRoughing:  
FUNCTION <DetrFunction>**

Sets the detrouching function.

**Parameters:**

<DetrFunction> F1 | F2 | F3  
\*RST: F1

**Example:** see [Example "Generating an RF envelope signal and defining the shaping function"](#) on page 84

**Manual operation:** See ["Detrouching Function"](#) on page 38

---

**[:SOURce<hw>]:IQ:OUTPut[:ANALog]:ENVELOpe:SHAPing:DETRoughing:  
COUPling <CouplingState>**

Enables/disables deriving the detrouching factor (d) from the selected  $V_{cc}$  value.

**Parameters:**

<CouplingState> 0 | 1 | OFF | ON  
\*RST: 0

**Example:** see [Example "Generating an RF envelope signal and defining the shaping function"](#) on page 84

**Manual operation:** See ["Couple Detrouching Factor with Vcc"](#) on page 38

---

**[:SOURce<hw>]:IQ:OUTPut[:ANALog]:ENVELOpe:SHAPing:DETRoughing:  
FACTor <DetrFactor>**

Sets the detrouching factor.

**Parameters:**

<DetrFactor> float  
Range: 0 to 2  
Increment: 1E-3  
\*RST: 0.2

**Example:** see [Example "Generating an RF envelope signal and defining the shaping function"](#) on page 84

**Manual operation:** See ["Detrouching Factor \(d\)"](#) on page 39

---

**[:SOURce<hw>]:IQ:OUTPut[:ANALog]:ENVELOpe:SHAPing:DETRoughing:  
PEXPonent <PowerExponent>**

Sets the exponent (a) for the detrouching function  $F^3$ .

**Parameters:**

<PowerExponent> float  
 Range: 1 to 10  
 Increment: 1E-3  
 \*RST: 2

**Example:** see [Example "Generating an RF envelope signal and defining the shaping function"](#) on page 84

**Manual operation:** See ["Exponent \(a\)"](#) on page 39

## 7.3 SOURce:IQ:DPD Subsystem

The SOURce:IQ:DPD subsystem contains the commands for enabling and configuring of digital predistortion.

For information about the required options, see [Chapter 4.1, "Required Options"](#), on page 46.

**Example: Defining correction coefficients and enabling digital predistortion**

```
*RST

// enable LTE signal
SOURcel:BB:EUTRa:SETTing:TMOD:DL "E-TM1_1__5MHz"
SOURcel:BB:EUTRa:STATe 1

// define the RF level and frequency
SOURcel:FREQuency:CW 214300000
SOURcel:POWer:LEVel:IMMediate:AMPLitude -15

SOURcel:IQ:DPD:PIN:MIN -35
SOURcel:IQ:DPD:PIN:MAX -2.5

// select look-up table files with correction values
SOURcel:IQ:DPD:SHAPing:MODE TABLE
SOURcel:IQ:DPD:SHAPing:TABLE:AMAM:FILE:CATalog?
// Response: My_DPD_AM-AM,MyDPD_AM-AM
SOURcel:IQ:DPD:SHAPing:TABLE:AMAM:FILE:SElect "My_DPD_AM-AM"
SOURcel:IQ:DPD:SHAPing:TABLE:AMPM:FILE:CATalog?
// Response: My_DPD_AM-PM,MyDPD_AM-PM
SOURcel:IQ:DPD:SHAPing:TABLE:AMPM:FILE:SElect "My_DPD_AM-PM"
SOURcel:IQ:DPD:SHAPing:TABLE:INTerp LINer
SOURcel:IQ:DPD:SHAPing:TABLE:INVert?
// Response: 0

// enable digital predistortion
```

```

SOURce:IQ:DPD:AMPM:AMFirst 1
SOURce:IQ:DPD:AMAM:STAtE 1
SOURce:IQ:DPD:AMPM:STAtE 1
SOURce:IQ:DPD:LREfereNce BDPD
SOURce:IQ:DPD:STAtE 1

// enable the output
SOURce:IQ:STAtE 1
OUTPut1:STAtE 1

// query the PEP, level and crest factor values before and after the DPD
SOURce:IQ:DPD:INPut:PEP?
// Response: -3.43
SOURce:IQ:DPD:INPut:LEVel?
// Response: -15
SOURce:IQ:DPD:INPut:CFACTOR?
// Response: 11.57

SOURce:IQ:DPD:OUTPut:PEP?
SOURce:IQ:DPD:OUTPut:LEVel?
SOURce:IQ:DPD:OUTPut:CFACTOR?

// change level reference and
// query the PEP, level and crest factor values before and after the DPD
SOURce:IQ:DPD:LREfereNce ADPD
SOURce:IQ:DPD:OUTPut:ERRor:MAX 0.1
SOURce:IQ:DPD:OUTPut:ITERations:MAX 3
SOURce:IQ:DPD:MEASurement:STAtE?
// Response: 1
SOURce:IQ:DPD:OUTPut:ERRor?
// Response: 0
SOURce:IQ:DPD:OUTPut:PEP?
// Response: -3.57
SOURce:IQ:DPD:OUTPut:LEVel?
// Response: -15
SOURce:IQ:DPD:OUTPut:CFACTOR?
// Response: 11.43

// enable static DPD and set the pre-gain
// SOURce:IQ:DPD:LREfereNce SDPD
// SOURce:IQ:DPD:GAIN:PRE -18
// set the predistorion values in raw format
// SOURce:IQ:DPD:SHAPing:TABLE:AMAM:FILE:DATA -30.4,-5.2, -25.1,-4.5, -18.5,-2.5, -10.5,-1
// SOURce:IQ:DPD:SHAPing:TABLE:AMPM:FILE:DATA -30.4, -5, -25.1, 5, -10, 0
// SOURce:IQ:DPD:SHAPing:TABLE:AMPM:FILE:CATalog?
// Response: My_DPD_AM-PM,MyDPD_AM-PM
// set the predistorion values and store them into a file
// SOURce:IQ:DPD:SHAPing:TABLE:AMPM:FILE:NEW "DPD_AM-PM_raw", -30.4, -5, -25.1, 5, -10, 0
// SOURce:IQ:DPD:SHAPing:TABLE:AMPM:FILE:CATalog?
// Response: My_DPD_AM-PM,MyDPD_AM-PM,DPD_AM-PM_raw

```

```

// SOURce1:IQ:DPD:AMPM:VALue:PEP?
// Response: 4.255
// SOURce1:IQ:DPD:AMPM:VALue:VALue? -30,DBM
// Response:-4.439

// change the shaping mode
SOURce1:IQ:DPD:SHAPing:MODE POLYnomial
// query files with polynomial functions in the default user directory
SOURce1:IQ:DPD:SHAPing:POLYnomial:COEFFicients:CATalog?
// Response: MyDTD_Poly,myDTD_Poly4th
SOURce1:IQ:DPD:SHAPing:POLYnomial:COEFFicients:LOAD "MyDTD_Poly4th"
SOURce1:IQ:DPD:SHAPing:POLYnomial:COEFFicients?
// Response: 0,0,-0.25,0.2,0.6,-0.3,0.3,0.3,0.5,-0.4
SOURce1:IQ:DPD:SHAPing:POLYnomial:COEFFicients:STORE "/var/user/myPoly.dpd_poly"

[:SOURce<hw>]:IQ:DPD:STATe..... 102
[:SOURce<hw>]:IQ:DPD:PRESet..... 102
[:SOURce<hw>]:IQ:DPD:SETTing:CATalog?..... 102
[:SOURce<hw>]:IQ:DPD:SETTing:DELeTe..... 103
[:SOURce<hw>]:IQ:DPD:SETTing:LOAD..... 103
[:SOURce<hw>]:IQ:DPD:SETTing:STORE..... 103
[:SOURce<hw>]:IQ:DPD:AMAM:STATe..... 103
[:SOURce<hw>]:IQ:DPD:AMPM:STATe..... 103
[:SOURce<hw>]:IQ:DPD:AMFirst..... 103
[:SOURce<hw>]:IQ:DPD:LREFeRence..... 104
[:SOURce<hw>]:IQ:DPD:OUTPut:ERRor?..... 104
[:SOURce<hw>]:IQ:DPD:OUTPut:ERRor:MAX..... 104
[:SOURce<hw>]:IQ:DPD:OUTPut:ITERations:MAX..... 105
[:SOURce<hw>]:IQ:DPD:MEASurement:STATe?..... 105
[:SOURce<hw>]:IQ:DPD:INPut:CFACtor?..... 105
[:SOURce<hw>]:IQ:DPD:OUTPut:CFACtor?..... 105
[:SOURce<hw>]:IQ:DPD:INPut:LEVel?..... 105
[:SOURce<hw>]:IQ:DPD:OUTPut:LEVel?..... 105
[:SOURce<hw>]:IQ:DPD:INPut:PEP?..... 105
[:SOURce<hw>]:IQ:DPD:OUTPut:PEP?..... 105
[:SOURce<hw>]:IQ:DPD:PIN:MIN..... 105
[:SOURce<hw>]:IQ:DPD:PIN:MAX..... 105
[:SOURce<hw>]:IQ:DPD:GAIN:PRE..... 106
[:SOURce<hw>]:IQ:DPD:SHAPing:MODE..... 106
[:SOURce<hw>]:IQ:DPD:SCALE..... 106
[:SOURce<hw>]:IQ:DPD:SHAPing:TABLE:AMAM:FILE:CATalog?..... 107
[:SOURce<hw>]:IQ:DPD:SHAPing:TABLE:AMPM:FILE:CATalog?..... 107
[:SOURce<hw>]:IQ:DPD:SHAPing:TABLE:AMAM:FILE[:SElect]..... 107
[:SOURce<hw>]:IQ:DPD:SHAPing:TABLE:AMPM:FILE[:SElect]..... 107
[:SOURce<hw>]:IQ:DPD:SHAPing:TABLE:AMAM:FILE:NEW..... 107
[:SOURce<hw>]:IQ:DPD:SHAPing:TABLE:AMPM:FILE:NEW..... 107
[:SOURce<hw>]:IQ:DPD:SHAPing:TABLE:AMAM:FILE:DATA..... 108
[:SOURce<hw>]:IQ:DPD:SHAPing:TABLE:AMPM:FILE:DATA..... 108
[:SOURce<hw>]:IQ:DPD:SHAPing:TABLE:INTerp..... 108
[:SOURce<hw>]:IQ:DPD:SHAPing[:TABLE]:INVert..... 108

```

<code>[:SOURce&lt;hw&gt;]:IQ:DPD:SHAPing:POLYnomial:COEFFicients</code> .....	108
<code>[:SOURce&lt;hw&gt;]:IQ:DPD:SHAPing:POLYnomial:COEFFicients:CATalog?</code> .....	109
<code>[:SOURce&lt;hw&gt;]:IQ:DPD:SHAPing:POLYnomial:COEFFicients:LOAD</code> .....	109
<code>[:SOURce&lt;hw&gt;]:IQ:DPD:SHAPing:POLYnomial:COEFFicients:STORE</code> .....	109
<code>[:SOURce&lt;hw&gt;]:IQ:DPD:SHAPing:NORMalized:DATA</code> .....	109
<code>[:SOURce&lt;hw&gt;]:IQ:DPD:SHAPing:NORMalized:DATA:CATalog?</code> .....	110
<code>[:SOURce&lt;hw&gt;]:IQ:DPD:SHAPing:NORMalized:DATA:LOAD</code> .....	110
<code>[:SOURce&lt;hw&gt;]:IQ:DPD:SHAPing:NORMalized:DATA:STORE</code> .....	111
<code>[:SOURce&lt;hw&gt;]:IQ:DPD:AMAM:VALue:LEVel?</code> .....	111
<code>[:SOURce&lt;hw&gt;]:IQ:DPD:AMPM:VALue:LEVel?</code> .....	111
<code>[:SOURce&lt;hw&gt;]:IQ:DPD:AMAM:VALue:PEP?</code> .....	111
<code>[:SOURce&lt;hw&gt;]:IQ:DPD:AMPM:VALue:PEP?</code> .....	111
<code>[:SOURce&lt;hw&gt;]:IQ:DPD:AMAM:VALue?</code> .....	112
<code>[:SOURce&lt;hw&gt;]:IQ:DPD:AMPM:VALue?</code> .....	112
<code>[:SOURce&lt;hw&gt;]:IQ:DPD:LRF:STATe</code> .....	112
<code>[:SOURce&lt;hw&gt;]:IQ:DPD:LRF:ADJJust?</code> .....	113

---

#### `[:SOURce<hw>]:IQ:DPD:STATe <State>`

Enabels/disables the generation of digitally pre-distorted signals.

##### Parameters:

<State>                    0 | 1 | OFF | ON  
 \*RST:                    0

**Example:**                See [Example "Defining correction coefficients and enabling digital predistortion"](#) on page 99

**Manual operation:**    See ["State"](#) on page 54

---

#### `[:SOURce<hw>]:IQ:DPD:PRESet`

Sets the default DPD settings (\*RST values specified for the commands).

Not affected is the state set with the command `[:SOURce<hw>]:IQ:DPD:STATe`.

**Usage:**                    Event

**Manual operation:**    See ["Set to Default"](#) on page 54

---

#### `[:SOURce<hw>]:IQ:DPD:SETTing:CATalog?`

Queries the files with digital predistortion setting in the default directory. Listed are files with the file extension \* .dpd.

##### Return values:

<Catalog>                "<filename1>,<filename2>,..."  
 Returns a string of file names separated by commas.

**Usage:**                    Query only

**Manual operation:**    See ["Save/Recall"](#) on page 54

---

**[ :SOURce<hw> ]:IQ:DPD:SETTing:DELete <Filename>**

Deletes the selected file from the default or specified directory. Deleted are files with the file extension \* .dpd.

**Setting parameters:**

<Filename> string

**Usage:** Setting only

**Manual operation:** See ["Save/Recall"](#) on page 54

---

**[ :SOURce<hw> ]:IQ:DPD:SETTing:LOAD <Filename>**

Loads the selected file from the default or the specified directory. Loaded are files with extension \* .dpd.

**Setting parameters:**

<Filename> string

**Usage:** Setting only

**Manual operation:** See ["Save/Recall"](#) on page 54

---

**[ :SOURce<hw> ]:IQ:DPD:SETTing:STORe <Filename>**

Stores the current settings into the selected file; the file extension ( \* .dpd ) is assigned automatically.

**Setting parameters:**

<Filename> string

**Usage:** Setting only

**Manual operation:** See ["Save/Recall"](#) on page 54

---

**[ :SOURce<hw> ]:IQ:DPD:AMAM:STATe <State>****[ :SOURce<hw> ]:IQ:DPD:AMPM:STATe <State>**

Enabels/disables the AM/AM and AM/PM digital predistortion.

**Parameters:**

<State> 0 | 1 | OFF | ON

\*RST: 0

**Example:** see [Example "Defining correction coefficients and enabling digital predistortion"](#) on page 99

**Manual operation:** See ["AM/AM and AM/PM State"](#) on page 55

---

**[ :SOURce<hw> ]:IQ:DPD:AMFirst <AmAmFirstState>**

Sets that the AM/AM predistortion is applied before the AM/PM.

**Parameters:**

<AmAmFirstState> 0 | 1 | OFF | ON  
 \*RST: 0

**Example:** See [Example "Defining correction coefficients and enabling digital predistortion"](#) on page 99

**Manual operation:** See ["AM/AM First"](#) on page 54

**[:SOURce<hw>]:IQ:DPD:LREference <LevelReference>**

Sets whether a dynamic (BDPD | ADPD) or a static (SDPS) adaptation of the range the selected DPD is applied on.

**Parameters:**

<LevelReference> BDPD | ADPD | SDPD  
 \*RST: BDPD

**Example:** see [Example "Defining correction coefficients and enabling digital predistortion"](#) on page 99

**Manual operation:** See ["Level Reference"](#) on page 54

**[:SOURce<hw>]:IQ:DPD:OUTPut:ERRor?**

Queries the resulting level error.

**Return values:**

<AchievedError> float

**Example:** see [Example "Defining correction coefficients and enabling digital predistortion"](#) on page 99

**Usage:** Query only

**Manual operation:** See ["Achieved Output Level Error"](#) on page 55

**[:SOURce<hw>]:IQ:DPD:OUTPut:ERRor:MAX <MaximumError>**

Sets the allowed maximum error.

**Parameters:**

<MaximumError> float  
 Range: 0.01 to 1  
 Increment: 0.01  
 \*RST: 0.1

**Example:** see [Example "Defining correction coefficients and enabling digital predistortion"](#) on page 99

**Manual operation:** See ["Maximum Output Level Error"](#) on page 55  
 See ["Maximum Number of Iteractions"](#) on page 55



---

**[ :SOURce<hw>]:IQ:DPD:OUTPut:ITERations:MAX <MaxIterations>**

Sets the maximum number of performed iterations to achieving the required error set with `[ :SOURce<hw>]:IQ:DPD:OUTPut:ERRor:MAX`.

**Parameters:**

<MaxIterations> integer  
 Range: 1 to 10  
 \*RST: 3

**Example:** See [Example "Defining correction coefficients and enabling digital predistortion"](#) on page 99

---

**[ :SOURce<hw>]:IQ:DPD:MEASurement:STATe?**

Queries whether the interactions are competed.

**Return values:**

<MeasureValidity> 0 | 1 | OFF | ON  
 \*RST: 1

**Example:** see [Example "Defining correction coefficients and enabling digital predistortion"](#) on page 99

**Usage:** Query only

---

**[ :SOURce<hw>]:IQ:DPD:INPut:CFACTOR?**  
**[ :SOURce<hw>]:IQ:DPD:OUTPut:CFACTOR?**  
**[ :SOURce<hw>]:IQ:DPD:INPut:LEVel?**  
**[ :SOURce<hw>]:IQ:DPD:OUTPut:LEVel?**  
**[ :SOURce<hw>]:IQ:DPD:INPut:PEP?**  
**[ :SOURce<hw>]:IQ:DPD:OUTPut:PEP?**

Queries the measured values the before and after the enabled digital predistortion.

**Return values:**

<PEP> float  
 The query returns  $-1000$  if the calculation is impossible or there are no measurements results available.

**Example:** see [Example "Defining correction coefficients and enabling digital predistortion"](#) on page 99

**Usage:** Query only

**Manual operation:** See ["Input/Output PEP, Level and Crest Factor"](#) on page 55

---

**[ :SOURce<hw>]:IQ:DPD:PIN:MIN <PepInMin>**  
**[ :SOURce<hw>]:IQ:DPD:PIN:MAX <PepInMax>**

Sets the value range of the input power.

**Parameters:**

<PepInMax> float  
 Range: -145 to 20  
 Increment: 0.01  
 \*RST: 10

**Example:** see [Example "Defining correction coefficients and enabling digital predistortion"](#) on page 99

**Manual operation:** See ["Input Range \(PEP<sub>in</sub>\)"](#) on page 58

**[SOURce<hw>]:IQ:DPD:GAIN:PRE <PreGain>**

Sets a pre-gain (i.e. an attenuation) to define the range the static DPD is applied in.

**Parameters:**

<PreGain> float  
 Range: -50 to 20  
 Increment: 1E-2  
 \*RST: 0

**Example:** see [Example "Defining correction coefficients and enabling digital predistortion"](#) on page 99

**Manual operation:** See ["Pre-Gain"](#) on page 58

**[SOURce<hw>]:IQ:DPD:SHAPing:MODE <Shaping>**

Selects the method to define the correction coefficients.

**Parameters:**

<Shaping> TABLE | POLYnomial | NORMalized  
 \*RST: TABLE

**Example:** see [Example "Defining correction coefficients and enabling digital predistortion"](#) on page 99

**Manual operation:** See ["Shaping"](#) on page 57

**[SOURce<hw>]:IQ:DPD:SCALE <Scale>**

Determines the units used on the x and y-axis.

**Parameters:**

<Scale> POWER | VOLTage  
 \*RST: POWER

**Manual operation:** See ["Scale"](#) on page 59

---

**[:SOURce<hw>]:IQ:DPD:SHAPing:TABLE:AMAM:FILE:CATalog?**

**[:SOURce<hw>]:IQ:DPD:SHAPing:TABLE:AMPM:FILE:CATalog?**

Queries the available table files in the default directory. Only files with the extension \*.dpd\_magn(AM/AM) or \*.dpd\_phase(AM/PM) are listed.

**Example:** see [Example "Defining correction coefficients and enabling digital predistortion"](#) on page 99

**Usage:** Query only

**Manual operation:** See ["Shaping Table"](#) on page 59

---

**[:SOURce<hw>]:IQ:DPD:SHAPing:TABLE:AMAM:FILE[:SElect] <Filename>**

**[:SOURce<hw>]:IQ:DPD:SHAPing:TABLE:AMPM:FILE[:SElect] <Filename>**

Selects a file with correction values (extension \*.dpd\_magn (AM/AM) or \*.dpd\_phase(AM/PM)).

**Parameters:**

<Filename> string

**Example:** see [Example "Defining correction coefficients and enabling digital predistortion"](#) on page 99

**Manual operation:** See ["Shaping Table"](#) on page 59  
See ["Pin \(dBm\), Delta Power \(dB\) / Pin \(dBm\), Delta Phase \(deg\)"](#) on page 61

---

**[:SOURce<hw>]:IQ:DPD:SHAPing:TABLE:AMAM:FILE:NEW**

<Filename>,<Pin>,<Delta>

**[:SOURce<hw>]:IQ:DPD:SHAPing:TABLE:AMPM:FILE:NEW**

<Filename>,<Pin>,<Delta>

Stores the correction values into a file with the selected file name and loads it.

The file is stored in the default directory or in the directory specified with the absolute file path. If the file does not yet exist, a new file is created. The file extension is assigned automatically.

**Setting parameters:**

<Filename> string

<Pin>,<Delta> Value pairs, describing the absolute input power  $P_{in}$  and the delta values for amplitude or phase.

**Example:** See [Example "Defining correction coefficients and enabling digital predistortion"](#) on page 99

**Usage:** Setting only

**[ :SOURce<hw>]:IQ:DPD:SHAPing:TABLE:AMAM:FILE:DATA**

&lt;Pin&gt;,&lt;Delta&gt;[,&lt;Pin&gt;,&lt;Delta&gt;, ...]

**[ :SOURce<hw>]:IQ:DPD:SHAPing:TABLE:AMPM:FILE:DATA**

&lt;Pin&gt;,&lt;Delta&gt;[,&lt;Pin&gt;,&lt;Delta&gt;, ...]

Defines the predistortion function in a raw data format.

See also [\[ :SOURce<hw>\]:IQ:DPD:SHAPing:TABLE:AMPM:FILE:NEW](#) on page 107.**Parameters:**

<Pin>,<Delta>      Sequence of up to 4000 comma-separated value pairs, describing the absolute input power  $P_{in}$  and the delta values for amplitude or phase.

**Example:**      See [Example "Defining correction coefficients and enabling digital predistortion"](#) on page 99

**[ :SOURce<hw>]:IQ:DPD:SHAPing:TABLE:INTerp <Interpolation>**

Enables a linear (voltage or power) interpolation between the defined correction values.

**Parameters:**

<Interpolation>      OFF | POWER | LINear

**POWER**  
Linear power interpolation

**LINear**  
Linear voltage interpolation

\*RST:      OFF

**Example:**      see [Example "Defining correction coefficients and enabling digital predistortion"](#) on page 99

**Manual operation:**      See ["Interpolation"](#) on page 57

**[ :SOURce<hw>]:IQ:DPD:SHAPing[:TABLE]:INVert <InvertValues>**

Inverts the defined correction values.

**Parameters:**

<InvertValues>      0 | 1 | OFF | ON

\*RST:      0

**Example:**      see [Example "Defining correction coefficients and enabling digital predistortion"](#) on page 99

**Manual operation:**      See ["Invert correction values"](#) on page 57

**[ :SOURce<hw>]:IQ:DPD:SHAPing:POLYnomial:COEFFicients**

Sets the polynomial coefficients.

**Example:** see [Example "Defining correction coefficients and enabling digital predistortion"](#) on page 99

**Manual operation:** See ["Polynomial Order"](#) on page 65  
See ["Polynomial coefficients"](#) on page 65

#### **[:SOURce<hw>]:IQ:DPD:SHAPing:POLYnomial:COEFFicients:CATalog?**

Queries the available polynomial files in the default directory. Only files with the file extension \*.dpd\_poly are listed.

**Example:** see [Example "Defining correction coefficients and enabling digital predistortion"](#) on page 99

**Usage:** Query only

**Manual operation:** See ["Save/Recall Polynomial"](#) on page 64

#### **[:SOURce<hw>]:IQ:DPD:SHAPing:POLYnomial:COEFFicients:LOAD <Filename>**

Loads the selected polynomial file.

##### **Setting parameters:**

<Filename> string

**Example:** see [Example "Defining correction coefficients and enabling digital predistortion"](#) on page 99

**Usage:** Setting only

**Manual operation:** See ["Save/Recall Polynomial"](#) on page 64

#### **[:SOURce<hw>]:IQ:DPD:SHAPing:POLYnomial:COEFFicients:STORE <Filename>**

Saves the polynomial function as polynomial file.

##### **Setting parameters:**

<Filename> string

**Example:** see [Example "Defining correction coefficients and enabling digital predistortion"](#) on page 99

**Usage:** Setting only

**Manual operation:** See ["Save/Recall Polynomial"](#) on page 64

#### **[:SOURce<hw>]:IQ:DPD:SHAPing:NORMALized:DATA <#><LengthOfNrOfBytes><NrOfBytes><NormData>**

Defines the normalized predistortion function in a raw data format (binary data).

##### **Parameters:**

<#> The binary data must start with the sign #

<LengthOfNrOfBytes>ASCII format

Sets the length of <NrOfBytes>, i.e. the number of digits used to write <NrOfBytes>

<NrOfBytes>

An ASCII integer value that specifies the number of bytes that follow in the <NormData> part

Each of the <NormData> parameters is coded with 8 bytes.

Then the number of bytes <NrOfBytes> is calculated as:

$\langle \text{NrOfBytes} \rangle = 8 + 8 + n(8+8+8)$ , where  $n$  is the number of points <NoOfPoints>.

**Setting parameters:**

<NormData>

<PinMax><NoOfPoints>{<VinVmax><DeltaV><DeltaPhase>}

Values in **binary format**, describing the maximum absolute input power  $\text{Pin}_{\text{max}}$ , the number of subsequent points  $n$  and the normalized values  $\text{Vin}/V_{\text{max}}$ ,  $\Delta V/V$ ,  $\Delta \text{Phase}$  [deg].

**Example:**

```
SOURce1:IQ:DPD:SHAPing:NORMalized:DATA #240<values>
// the binary <values> are not printable
SOURce1:IQ:DPD:SHAPing:NORMalized:DATA:CATalog?
// norm
SOURce1:IQ:DPD:SHAPing:NORMalized:DATA:STORe "My_DPD_Normalized"
SOURce1:IQ:DPD:SHAPing:NORMalized:DATA:CATalog?
// norm,My_DPD_Normalized
SOURce1:IQ:DPD:SHAPing:NORMalized:DATA:LOAD "norm"
SOURce1:IQ:DPD:SHAPing:NORMalized:DATA?
// #3112
// the binary data <NormData> is 112 bytes long, i.e. 3 points are defined
// binary data is machine readable but not printable
```

**Manual operation:** See "[Pin<sub>max</sub>](#)" on page 67

See "[Vin/Vmax, ΔV/V, ΔPhase \(deg\)](#)" on page 67

**[ :SOURce<hw>]:IQ:DPD:SHAPing:NORMalized:DATA:CATalog?**

Queries the available files with normalized data in the default directory. Only files with the file extension \*.dpd\_norm are listed.

**Example:**

see [\[:SOURce<hw>\]:IQ:DPD:SHAPing:NORMalized:DATA](#) on page 109

**Usage:**

Query only

**Manual operation:**

See "[Save/Recall Normalized Data](#)" on page 67

**[ :SOURce<hw>]:IQ:DPD:SHAPing:NORMalized:DATA:LOAD <Filename>**

Loads the selected file.

**Setting parameters:**

<Filename> string

**Example:** see `[ :SOURce<hw> ] :IQ:DPD:SHAPing:NORMAlized:DATA`  
on page 109

**Usage:** Setting only

**Manual operation:** See ["Save/Recall Normalized Data"](#) on page 67

`[ :SOURce<hw> ] :IQ:DPD:SHAPing:NORMAlized:DATA:STORe <Filename>`

Saves the normalized data in a file.

**Setting parameters:**

<Filename> string

**Example:** see `[ :SOURce<hw> ] :IQ:DPD:SHAPing:NORMAlized:DATA`  
on page 109

**Usage:** Setting only

**Manual operation:** See ["Save/Recall Normalized Data"](#) on page 67

`[ :SOURce<hw> ] :IQ:DPD:AMAM:VALue:LEVel?`

`[ :SOURce<hw> ] :IQ:DPD:AMPM:VALue:LEVel?`

Queries the delta phase and delta power values of the current RF RMS power level.

**Return values:**

<DeltaPhase> float  
Range: -180 to 180  
Increment: 0.01  
\*RST: 0

<DeltaPower> float  
Range: -20 to 20  
Increment: 0.01  
\*RST: 0

**Example:** see [Example "Defining correction coefficients and enabling digital predistortion"](#) on page 99

**Usage:** Query only

**Manual operation:** See ["AM/AM and AM/PM Diagrams"](#) on page 59

`[ :SOURce<hw> ] :IQ:DPD:AMAM:VALue:PEP?`

`[ :SOURce<hw> ] :IQ:DPD:AMPM:VALue:PEP?`

Queries the delta phase and delta power values for the current PEP of the generated RF signal.

**Return values:**

<DeltaPhase>	float
	Range: -180 to 180
	Increment: 0.01
	*RST: 0
<DeltaPower>	float
	Range: -20 to 20
	Increment: 0.01
	*RST: 0

**Example:** see [Example "Defining correction coefficients and enabling digital predistortion"](#) on page 99

**Usage:** Query only

**Manual operation:** See ["AM/AM and AM/PM Diagrams"](#) on page 59

**[ :SOURce<hw> ]:IQ:DPD:AMAM:VALue?**

**[ :SOURce<hw> ]:IQ:DPD:AMPM:VALue?**

Queries the delta phase and delta power values for the selected <xValue>.

**Query parameters:**

<xValue>	float
	Value on the x-axis
	Value range depends on the selected PEP <sub>inMin</sub> and PEP <sub>inMax</sub> values.
<xUnit>	DBM   V
	*RST: DBM

**Return values:**

<DeltaPhase>	float
	Range: -180 to 180
	Increment: 0.01
	*RST: 0
<DeltaPower>	float
	Range: -20 to 20
	Increment: 0.01
	*RST: 0

**Example:** see [Example "Defining correction coefficients and enabling digital predistortion"](#) on page 99

**Usage:** Query only

**Manual operation:** See ["AM/AM and AM/PM Diagrams"](#) on page 59

**[ :SOURce<hw> ]:IQ:DPD:LRF:STATe <LinearizeRf>**

Activates linearization of the RF.



**Parameters:**

<LinearizeRf> 0 | 1 | OFF | ON  
\*RST: 0

**Example:**

```
SOURce1:IQ:DPD:LRF:STATe 1
SOURce1:IQ:DPD:LRF:ADJust?
// Response: 0
```

**Manual operation:** See "[Linearize RF](#)" on page 68

---

**[:SOURce<hw>]:IQ:DPD:LRF:ADJust?**

Calculates the predistortion values for the current frequency.

**Return values:**

<AdjustResult> 0 | 1 | RUNning | STOPped  
\*RST: STOPped

**Usage:** Query only

**Manual operation:** See "[Adjust Linearization Current Frequency](#)" on page 69

## List of Commands

[:SOURce<hw>]:IQ:DPD:AMAM:STATe.....	103
[:SOURce<hw>]:IQ:DPD:AMAM:VALue:LEVel?.....	111
[:SOURce<hw>]:IQ:DPD:AMAM:VALue:PEP?.....	111
[:SOURce<hw>]:IQ:DPD:AMAM:VALue?.....	112
[:SOURce<hw>]:IQ:DPD:AMFirst.....	103
[:SOURce<hw>]:IQ:DPD:AMPM:STATe.....	103
[:SOURce<hw>]:IQ:DPD:AMPM:VALue:LEVel?.....	111
[:SOURce<hw>]:IQ:DPD:AMPM:VALue:PEP?.....	111
[:SOURce<hw>]:IQ:DPD:AMPM:VALue?.....	112
[:SOURce<hw>]:IQ:DPD:GAIN:PRE.....	106
[:SOURce<hw>]:IQ:DPD:INPut:CFACTOR?.....	105
[:SOURce<hw>]:IQ:DPD:INPut:LEVel?.....	105
[:SOURce<hw>]:IQ:DPD:INPut:PEP?.....	105
[:SOURce<hw>]:IQ:DPD:LREference.....	104
[:SOURce<hw>]:IQ:DPD:LRf:ADJust?.....	113
[:SOURce<hw>]:IQ:DPD:LRf:STATe.....	112
[:SOURce<hw>]:IQ:DPD:MEASurement:STATe?.....	105
[:SOURce<hw>]:IQ:DPD:OUTPut:CFACTOR?.....	105
[:SOURce<hw>]:IQ:DPD:OUTPut:ERRor:MAX.....	104
[:SOURce<hw>]:IQ:DPD:OUTPut:ERRor?.....	104
[:SOURce<hw>]:IQ:DPD:OUTPut:ITERations:MAX.....	105
[:SOURce<hw>]:IQ:DPD:OUTPut:LEVel?.....	105
[:SOURce<hw>]:IQ:DPD:OUTPut:PEP?.....	105
[:SOURce<hw>]:IQ:DPD:PIN:MAX.....	105
[:SOURce<hw>]:IQ:DPD:PIN:MIN.....	105
[:SOURce<hw>]:IQ:DPD:PRESet.....	102
[:SOURce<hw>]:IQ:DPD:SCALE.....	106
[:SOURce<hw>]:IQ:DPD:SETTing:CATalog?.....	102
[:SOURce<hw>]:IQ:DPD:SETTing:DElete.....	103
[:SOURce<hw>]:IQ:DPD:SETTing:LOAD.....	103
[:SOURce<hw>]:IQ:DPD:SETTing:STORe.....	103
[:SOURce<hw>]:IQ:DPD:SHAPing:MODE.....	106
[:SOURce<hw>]:IQ:DPD:SHAPing:NORMalized:DATA.....	109
[:SOURce<hw>]:IQ:DPD:SHAPing:NORMalized:DATA:CATalog?.....	110
[:SOURce<hw>]:IQ:DPD:SHAPing:NORMalized:DATA:LOAD.....	110
[:SOURce<hw>]:IQ:DPD:SHAPing:NORMalized:DATA:STORe.....	111
[:SOURce<hw>]:IQ:DPD:SHAPing:POLYnomial:COEFFicients.....	108
[:SOURce<hw>]:IQ:DPD:SHAPing:POLYnomial:COEFFicients:CATalog?.....	109
[:SOURce<hw>]:IQ:DPD:SHAPing:POLYnomial:COEFFicients:LOAD.....	109
[:SOURce<hw>]:IQ:DPD:SHAPing:POLYnomial:COEFFicients:STORe.....	109
[:SOURce<hw>]:IQ:DPD:SHAPing:TABLE:AMAM:FILE:CATalog?.....	107
[:SOURce<hw>]:IQ:DPD:SHAPing:TABLE:AMAM:FILE:DATA.....	108
[:SOURce<hw>]:IQ:DPD:SHAPing:TABLE:AMAM:FILE:NEW.....	107
[:SOURce<hw>]:IQ:DPD:SHAPing:TABLE:AMAM:FILE[SElect].....	107
[:SOURce<hw>]:IQ:DPD:SHAPing:TABLE:AMPM:FILE:CATalog?.....	107
[:SOURce<hw>]:IQ:DPD:SHAPing:TABLE:AMPM:FILE:DATA.....	108
[:SOURce<hw>]:IQ:DPD:SHAPing:TABLE:AMPM:FILE:NEW.....	107

[ :SOURce<hw>]:IQ:DPD:SHAPing:TABLE:AMPM:FILE[:SElect]	107
[ :SOURce<hw>]:IQ:DPD:SHAPing:TABLE:INterp	108
[ :SOURce<hw>]:IQ:DPD:SHAPing:TABLE:INVert	108
[ :SOURce<hw>]:IQ:DPD:STATe	102
[ :SOURce<hw>]:IQ:OUTPut:ANALog:STATe	81
[ :SOURce<hw>]:IQ:OUTPut[:ANALog]:ENVELOpe:ADAPtion	87
[ :SOURce<hw>]:IQ:OUTPut[:ANALog]:ENVELOpe:BIAS	89
[ :SOURce<hw>]:IQ:OUTPut[:ANALog]:ENVELOpe:BINPut	91
[ :SOURce<hw>]:IQ:OUTPut[:ANALog]:ENVELOpe:DELAy	88
[ :SOURce<hw>]:IQ:OUTPut[:ANALog]:ENVELOpe:EMF[:STATe]	90
[ :SOURce<hw>]:IQ:OUTPut[:ANALog]:ENVELOpe:ETRAk	88
[ :SOURce<hw>]:IQ:OUTPut[:ANALog]:ENVELOpe:FDPD	88
[ :SOURce<hw>]:IQ:OUTPut[:ANALog]:ENVELOpe:GAIN	91
[ :SOURce<hw>]:IQ:OUTPut[:ANALog]:ENVELOpe:OFFSet	89
[ :SOURce<hw>]:IQ:OUTPut[:ANALog]:ENVELOpe:PIN:MAX	93
[ :SOURce<hw>]:IQ:OUTPut[:ANALog]:ENVELOpe:PIN:MIN	93
[ :SOURce<hw>]:IQ:OUTPut[:ANALog]:ENVELOpe:POWer:OFFSet?	94
[ :SOURce<hw>]:IQ:OUTPut[:ANALog]:ENVELOpe:RIN	90
[ :SOURce<hw>]:IQ:OUTPut[:ANALog]:ENVELOpe:SHAPing:COEFFicients	97
[ :SOURce<hw>]:IQ:OUTPut[:ANALog]:ENVELOpe:SHAPing:COEFFicients:CATalog?	97
[ :SOURce<hw>]:IQ:OUTPut[:ANALog]:ENVELOpe:SHAPing:COEFFicients:LOAD	97
[ :SOURce<hw>]:IQ:OUTPut[:ANALog]:ENVELOpe:SHAPing:COEFFicients:STORE	97
[ :SOURce<hw>]:IQ:OUTPut[:ANALog]:ENVELOpe:SHAPing:DETRoughing:COUPLing	98
[ :SOURce<hw>]:IQ:OUTPut[:ANALog]:ENVELOpe:SHAPing:DETRoughing:FACTor	98
[ :SOURce<hw>]:IQ:OUTPut[:ANALog]:ENVELOpe:SHAPing:DETRoughing:FUNCTion	98
[ :SOURce<hw>]:IQ:OUTPut[:ANALog]:ENVELOpe:SHAPing:DETRoughing:PEXPonent	98
[ :SOURce<hw>]:IQ:OUTPut[:ANALog]:ENVELOpe:SHAPing:FILE:CATalog?	95
[ :SOURce<hw>]:IQ:OUTPut[:ANALog]:ENVELOpe:SHAPing:FILE:DATA	96
[ :SOURce<hw>]:IQ:OUTPut[:ANALog]:ENVELOpe:SHAPing:FILE:NEW	96
[ :SOURce<hw>]:IQ:OUTPut[:ANALog]:ENVELOpe:SHAPing:FILE[:SElect]	95
[ :SOURce<hw>]:IQ:OUTPut[:ANALog]:ENVELOpe:SHAPing:GAIN:POST	95
[ :SOURce<hw>]:IQ:OUTPut[:ANALog]:ENVELOpe:SHAPing:GAIN:PRE	95
[ :SOURce<hw>]:IQ:OUTPut[:ANALog]:ENVELOpe:SHAPing:INterp	96
[ :SOURce<hw>]:IQ:OUTPut[:ANALog]:ENVELOpe:SHAPing:MODE	94
[ :SOURce<hw>]:IQ:OUTPut[:ANALog]:ENVELOpe:SHAPing:PV:FILE:CATalog?	95
[ :SOURce<hw>]:IQ:OUTPut[:ANALog]:ENVELOpe:SHAPing:PV:FILE:DATA	96
[ :SOURce<hw>]:IQ:OUTPut[:ANALog]:ENVELOpe:SHAPing:PV:FILE:NEW	96
[ :SOURce<hw>]:IQ:OUTPut[:ANALog]:ENVELOpe:SHAPing:PV:FILE[:SElect]	95
[ :SOURce<hw>]:IQ:OUTPut[:ANALog]:ENVELOpe:SHAPing:SCALE	94
[ :SOURce<hw>]:IQ:OUTPut[:ANALog]:ENVELOpe:STATe	87
[ :SOURce<hw>]:IQ:OUTPut[:ANALog]:ENVELOpe:TERMination	90
[ :SOURce<hw>]:IQ:OUTPut[:ANALog]:ENVELOpe:VCC:MAX	92
[ :SOURce<hw>]:IQ:OUTPut[:ANALog]:ENVELOpe:VCC:MIN	92
[ :SOURce<hw>]:IQ:OUTPut[:ANALog]:ENVELOpe:VCC:OFFSet	91
[ :SOURce<hw>]:IQ:OUTPut[:ANALog]:ENVELOpe:VCC:VALue:LEVel?	92
[ :SOURce<hw>]:IQ:OUTPut[:ANALog]:ENVELOpe:VCC:VALue:PEP?	92
[ :SOURce<hw>]:IQ:OUTPut[:ANALog]:ENVELOpe:VCC:VALue?	93
[ :SOURce<hw>]:IQ:OUTPut[:ANALog]:ENVELOpe:VOUt:MAX	89
[ :SOURce<hw>]:IQ:OUTPut[:ANALog]:ENVELOpe:VOUt:MIN	89
[ :SOURce<hw>]:IQ:OUTPut[:ANALog]:ENVELOpe:VPP[:MAX]	90

[:SOURce<hw>]:IQ:OUTPut[:ANALog]:ENVELOpe:VREF.....	88
[:SOURce<hw>]:IQ:OUTPut[:ANALog]:PRESet.....	81
[:SOURce<hw>]:IQ:OUTPut[:ANALog]:SETTing:CATalog?.....	81
[:SOURce<hw>]:IQ:OUTPut[:ANALog]:SETTing:DELeTe.....	82
[:SOURce<hw>]:IQ:OUTPut[:ANALog]:SETTing:LOAD.....	82
[:SOURce<hw>]:IQ:OUTPut[:ANALog]:SETTing:STORE.....	82
[:SOURce<hw>]:IQ:OUTPut[:ANALog]:TYPE.....	82

# Index

## A

AM/AM predistortion	
Normalized data	67
Shaping table	61
AM/AM, AM/PM	
Invert correction values	57
Predistortion	46
State	55
Which DPD applies first	54
AM/PM predistortion	
Normalized data	67
Shaping table	61
Application cards	7
Application notes	7
Apply	
Normalized data	67
Polynomial function	45, 65

## B

Basics	
Fill table	43, 61
Bias	
Envelope, E	26
Inverted envelope, E BAR	26
Bipolar input	
DC modulator	28
Brochures	7

## C

Circuit board	
Peak-to-Peak voltage	25
Common voltage mode	
DC modulator	27
Conventions	
SCPI commands	80
Coordinates, polynomial	
Cartesian	65
Cylindrical	65
Correction values, AM/AM AM/PM	
Invert	57
Couple	
Detrouching factor with Vcc	38
Create	
Shaping table	39, 59

## D

Data sheets	7
DC modulator	
Bipolar input	28
Characteristics	27
Common voltage mode	27
Driving voltage, peak-to-peak	29
Gain	29
Impedance	27
Input impedance	27
Input termination	27
Supply voltage offset	29
Termination	27
Vcc offset	29
Vpp	29

Default settings	
Digital predistortion	54
I/Q output analog	23
Delta power, delta phase	
Shaping table	61
Detrouching	
Exponent, RF envelope	39
Factor, couple with Vcc	38
Factor, RF envelope	39
Function, RF envelope	38
Detrouching function	
About	15
Settings	38, 39
DIFF I/Q OUT	
See I/Q OUT BAR	25
Digital predistortion	
Achieved level error	55
Enable	54
Enable AM/AM, AM/PM	55
First AM/AM or AM/PM	54
Invert correction values	57
Level reference	54
Maximum interactions	55
Maximum level error	55
Range	54
RF envelope	33
Static DPD	54
Documentation overview	5
DPD	
Normalized data	67
see predistortion, digital	46
Shape	57
Shaping table	61

## E

Edit	
Shaping table	39, 59
Effect of ET	
Observing, how to	12
EMF	
DC modulator	27
Enable	
AM/AM, AM/PM	55
Envelope detector	12
Envelope shaping	
Detrouching, settings	34
Linear, settings	34
Polynomial, settings	34
Table (LUT), settings	34
Envelope tracking	
After predistortion	32
How to	70
Settings	31
Envelope Tracking	
Envelope shaping	13
Envelope tracking power amplifiers tests	24
Envelope voltage	
Range	25
Reference	25
Set by Vcc	25
Envelope voltage Vout	12

ET		
Envelope tracking	70	
Suitable BB signal	12	
Exponent		
Detrouching, RF envelope	39	
<b>F</b>		
File format		
DPD, normalized data	51	
DPD, polynomial	49	
DPD, table	50	
Envelope shaping file, polynomial	16	
Envelope shaping file, table	16	
File save		
Shaping table	42, 61	
Fill table		
Basics	43, 61	
<b>G</b>		
Gain		
DC modulator	29	
Getting started	6	
Graphic, DPD		
Scale	59	
Graphic, ET shaping		
Scale	41	
Ground		
Termination, DC modulator	27	
<b>H</b>		
High crest factor signals		
How to test the PA	70	
Hotspots		
Envelope tracking	31	
<b>I</b>		
I/Q Impairments		
Non-linear	46	
I/Q modulator		
Nonlinearity	47	
I/Q output		
RF envelope	24	
I/Q output type		
Differential	25	
Envelope, E	25	
Inverted envelope, E BAR	25	
Single ended	25	
Impairment		
Non-linear	46	
Input impedance		
DC modulator	27	
Input power		
Power offset, power amplifier	30	
Range, power amplifier	30, 58	
Installation	10	
Instrument security	7	
Interpolation		
Shaping table, DPD	57	
Shaping table, envelope tracking	40	
Invert correction values		
AM/AM, AM/PM	57	
<b>L</b>		
Linear function		
About	14	
Settings	39	
Linearize RF	67	
Activate	68	
Adjust current frequency	69	
Look up table, LUT		
DPD, Settings	57	
Enabling, settings	34	
<b>M</b>		
Memory effects		
Preventing, settings	32	
MIPI Alliance		
Conform ET signal	28	
<b>N</b>		
Normalized data		
File format	51	
Pin,max	67	
Predistortion	59	
Save in file	67	
<b>O</b>		
Offset		
Envelope, E	26	
Inverted envelope, E BAR	26	
Supply voltage Vcc	29	
Online help	6	
Output voltage		
Envelope detector	25	
<b>P</b>		
PA		
Power amplifier	70	
PA for high crest factor signals		
How to generate a test signal	70	
PAPR signal		
How to test	70	
Peak-to-peak driving voltage		
DC modulator	29	
Peak-to-Peak voltage		
Circuit board	25	
Polynomial coefficients		
Envelope	39	
Predistortion	59	
Polynomial constant		
Settings	45, 65	
Polynomial function		
About	15	
Coefficients	45, 65	
Constant	45, 65	
Coordinates	65	
File format	16, 49	
Order	45, 65	
Save in file	45, 64	
Settings	39, 43	
Polynomial order		
Settings	45, 65	
Power (dBm), Vout (V)		
Settings	42	

- Power amplifier
  - Input power, Pin ..... 30, 58
  - Power offset ..... 30
  - Supply voltage, Vcc ..... 30
- Power amplifier tests
  - Envelope tracking ..... 70
  - How to ..... 70
- Power amplifiers testing
  - Envelope ..... 24
- Power offset
  - Cable loss compensation ..... 30
- Predistortion
  - Digital ..... 46
  - Interpolation, shaping table ..... 57
  - RF linearization ..... 67
  - Shaping table ..... 59
- Predistortion, digital
  - AM/AM, AM/PM ..... 46
  - Shape ..... 57
- R**
- Raw data format
  - DPD ..... 51
  - Envelope shaping file ..... 17
- Release notes ..... 7
- Remote control
  - Digital predistortion ..... 99
  - Predistortion ..... 99
  - Programming examples ..... 80
- RF envelope ..... 24
  - Delay envelope to RF ..... 32
  - Detrouching exponent ..... 39
  - Detrouching factor ..... 39
  - Detrouching factor, coupe with Vcc ..... 38
  - Detrouching function ..... 38
  - How to generate a control signal ..... 70
  - Interpolation, shaping table ..... 40
  - Polynomial shaping ..... 39
  - Shape defined in a file ..... 39
  - Shaping ..... 34
  - Shaping table ..... 39, 42
  - Voltage adaptation ..... 24
- S**
- Safety instructions ..... 7
- Save/recall
  - Normalized data ..... 67
  - Polynomial function ..... 45, 64
- Save/Recall
  - Digital predistortion ..... 54
  - I/Q output analog ..... 24
- Scale
  - Graphic, DPD ..... 59
  - Graphic, Envelope Tracing ..... 41
- Service manual ..... 6
- Shape
  - DPD, digital predistortion ..... 57
  - RF envelope ..... 33
  - see Envelope shaping ..... 34
- Shape, Predistortion
  - Polynomial ..... 57
  - Table (LUT), settings ..... 57
- Shaping
  - Range ..... 54
- Shaping function
  - see Envelope shaping ..... 34
- Shaping table
  - About ..... 16
  - Edit table ..... 41
  - File format ..... 16, 50
  - Interpolation ..... 40, 57
  - Power (dBm), Vout (V) ..... 42
  - Raw data ..... 17, 51
  - Save file ..... 42, 61
  - Select file ..... 39, 59
  - Settings ..... 39
  - Vin/Vmax, Vcc/Vmax ..... 42
- Shaping, DPD
  - Normalized data ..... 59, 67
  - Polynomial function ..... 59
  - Pre-gain ..... 58
  - Shaping table ..... 61
- Shaping, envelope
  - Polynomial function ..... 39
  - Post-gain ..... 39
  - Pre-gain ..... 39
  - Shaping table ..... 42, 61
- State
  - AM/AM, AM/PM ..... 55
  - Digital predistortion ..... 54
  - DPD ..... 54
- Supply voltage
  - Range ..... 30
- Supply voltage, offset
  - DC modulator ..... 29
- Supply voltage, PA
  - Detrouching ..... 38, 39
- T**
- Termination
  - DC modulator ..... 27
- Testing PA ..... 70
- Time delay, PA
  - Compensate, settings ..... 32
- Tutorials ..... 6
- U**
- User manual ..... 6
- V**
- Value range
  - Envelope voltage ..... 25
  - Pin, power amplifier ..... 30, 58
  - Vcc, power amplifier ..... 30
- Vcc offset
  - DC modulator ..... 29
- Vin/Vmax, Vcc/Vmax
  - Settings ..... 42
- Voltage adaptation
  - RF envelope ..... 24
- Vpp
  - DC modulator ..... 29
- W**
- White papers ..... 7
- Wire to wire
  - Termination, DC modulator ..... 27